

1

Connectors

Multifunctional adapters
for LV160 and LV320 Series
charging connectors

Catalogue A841.en

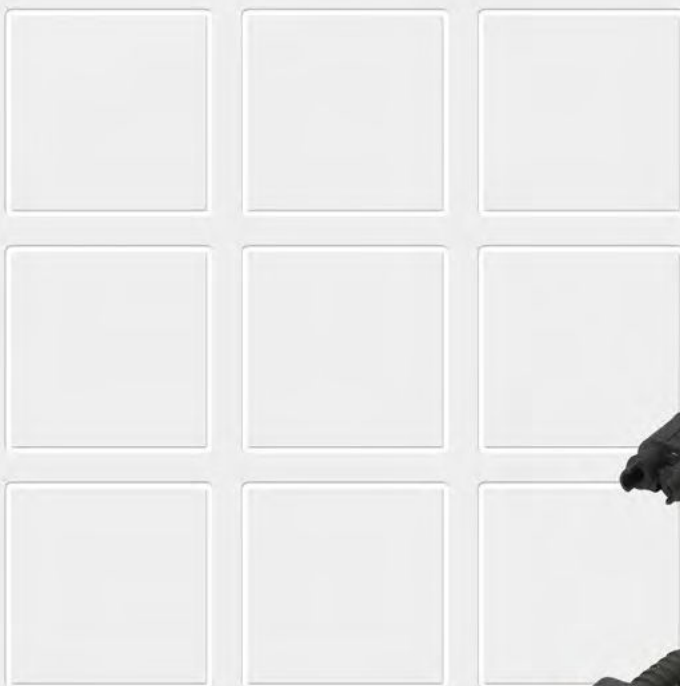

more information here:
schaltbau-gmbh.com

Multifunctional adapters for LV160 and LV320 Series charging connectors

Modular design of LV charging connectors extended

For companies which maintain their own lift truck fleet, battery management is crucial in sustaining truck uptime in their distribution centres.

Thanks to the modular design of the LV Series charging connectors Schaltbau can offer a flexible, scalable solution for the vehicle - battery - charger constellation.

Our new multifunctional adapter allows automatic water topping up of the battery cells through the coupled connector during the charge. For this purpose module holders can be attached to the connector shell in

Adapters available for the individual configuration of the charging connector that suits best your battery system:

- **Pilot contact adapter**
Fitted with 2 contacts the adapter can be used for providing a data link between battery and charger
- **Air tube adapter**
Air blow-in system for batteries with electrolyte circulation
- **Multifunctional adapter**
Multi purpose adapter for water top up and electrolyte circulation systems. The new feature that the flow of air and/or water is shut off when the connector is unmated ensures that no acid particles enter the interior of the vehicle.

various positions to accommodate the adapters.

This highly flexible solution includes the standard features of an optimized, ecological battery management:

- Topping up water in batteries
- Electrolyte circulation: low rate airflow is sent into the battery cells which prevents electrolyte stratification; airflow shut off when connector is disengaged
- Providing a data link between battery and charger via auxiliary and pilot contacts
- Battery charging with high continuous current-carrying capacity due to high-quality main contacts

Multifunctional adapter: Flow rate during water top up [litre/minute] depending on pressure [in bar]

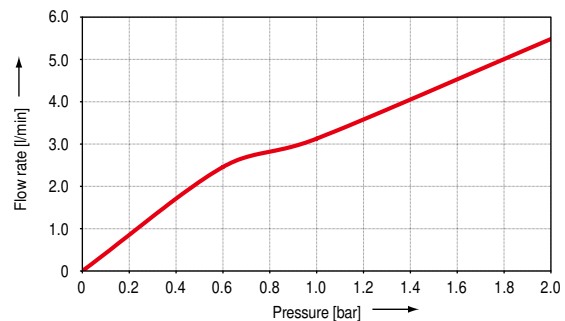

Specifications

Series LV160, LV320

	Multifunctional adapter	Air tube adapter	Pilot contact adapter
Assembly options *1			
Where to assemble	1 inside charging connector	2 in module holder on ⊕ side of charging connector	3 in module holder on ⊖ side of charging connector
Adapter used for	Water top up Electrolyte circulation system (ECS)	Electrolyte circulation system (ECS)	2 pilot contacts
Special feature	Flow of air or water shut off when not mated	Airflow not shut off when not mated	High-quality screw machine contacts, silver plated
Wire/tube cross-section	6 x 1,5 mm *2, *3	6 x 1,5 mm *2	crimping 2,5 mm ²
Contact diameter	---	---	4 mm
Max. current-carrying capacity	---	---	20 A
Tightness	4 bar max.	1 bar max.	---
Flow rate	see above diagram	800 l/h **	---
Acid resistance	1,38 g/cm ³ battery acid	1,38 g/cm ³ battery acid	1,38 g/cm ³ battery acid
Degree of protection (IEC 60529) *5	IP23	IP23	IP23
Operating temperature range	>0 °C *6 ... +65 °C	>0 °C ... +65 °C	-40 °C ... +110 °C
Mating cycles (EN 1175-1)	5,000	5,000	5,000

SCHALTBAU

*1 Depends on the number of module holders attached to the connector, see also "Ordering code" on page 4 and "Mounting options for module holders" on page 5

*2 Schaltbau has verified full functionality with the use of tube type Rauclair E6/1,5 from Rehau

*3 Tube pre-assembled, length 200 mm

*4 Leakage of pressure 30 mbar max. depending on flow rate

*5 Tested when mounted horizontally

*6 Please note that the water carrying parts of the connector must be kept free from freezing

Ordering code

Stock items

Series LV160, LV320

Example:

LV320-N-S70-0-2-M2-HW1-W1

Series

LV160
LV320Rated operating current
Main contacts 250 A
Main contacts 400 A

Keying

0
T
Nnone

grey, for wet-cell batteryMain contacts, wire cross-section*¹P95
P70
P50**Series LV320**
pin, 95 mm²
pin, 70 mm²
pin, 50 mm²

P50

Series LV160
pin, 50 mm²S95
S70
S50**Series LV320**
socket, 95 mm²
socket, 70 mm²
socket, 50 mm²

S50

Series LV160
socket, 50 mm²Pilot contacts²0
2
4none
two pilot contacts,
adapter included
four pilot contacts,
2 adapters included

Auxiliary contacts

0
2none
two auxiliary contacts
(no adapter needed)

Adapters

L0
L1
M1
A1none *³
air tube adapter
multifunctional adapter,
clamping ring for tube included
comprising both L1 and M1

Handle

H0
HW1/S
HW2/Snone
handle for use with module holders, black
handle for use with module holders, redModule holder⁴W0
W1none
twin module holder, top mounted

The tables represent our stock items which can be supplied in short delivery time.

LV320 with main contacts, 95 mm²

Connector	Ordering code	Description / Application
Battery receptacle	LV320-N-S95-0-0-M1-HW1-W0	multifunctional adapter
	LV320-N-S95-0-0-A1-HW1-W1	air tube and multifunct. adapter
	LV320-N-S95-0-0-L1-HW1-W0	air tube adapter for ECS ⁵
Charging plug	LV320-N-P95-0-0-M1-HW1-W0	multifunctional adapter
	LV320-N-P95-0-0-A1-HW1-W1	air tube and multifunct. adapter
	LV320-N-P95-0-0-L1-HW1-W0	air tube adapter for ECS ⁵

LV320 with main contacts, 70 mm²

Connector	Ordering code	Description / Application
Battery receptacle	LV320-N-S70-0-0-M1-HW1-W0	multifunctional adapter
	LV320-N-S70-0-0-A1-HW1-W1	air tube and multifunct. adapter
	LV320-N-S70-0-0-L1-HW1-W0	air tube adapter for ECS ⁵
Charging plug	LV320-N-P70-0-0-M1-HW1-W0	multifunctional adapter
	LV320-N-P70-0-0-A1-HW1-W1	air tube and multifunct. adapter
	LV320-N-P70-0-0-L1-HW1-W0	air tube adapter for ECS ⁵

LV320 with main contacts, 50 mm²

Connector	Ordering code	Description / Application
Battery receptacle	LV320-N-S50-0-0-M1-HW1-W0	multifunctional adapter
	LV320-N-S50-0-0-A1-HW1-W1	air tube and multifunct. adapter
	LV320-N-S50-0-0-L1-HW1-W0	air tube adapter for ECS ⁵
Charging plug	LV320-N-P50-0-0-M1-HW1-W0	multifunctional adapter
	LV320-N-P50-0-0-A1-HW1-W1	air tube and multifunct. adapter
	LV320-N-P50-0-0-L1-HW1-W0	air tube adapter for ECS ⁵

LV160 with main contacts, 50 mm²

Connector	Ordering code	Description / Application
Battery receptacle	LV160-N-S50-0-0-M1-HW1-W0	multifunctional adapter
	LV160-N-S50-0-0-A1-HW1-W1	air tube and multifunct. adapter
	LV160-N-S50-0-0-L1-HW1-W0	air tube adapter for ECS ⁵
Charging plug	LV160-N-P50-0-0-M1-HW1-W0	multifunctional adapter
	LV160-N-P50-0-0-A1-HW1-W1	air tube and multifunct. adapter
	LV160-N-P50-0-0-L1-HW1-W0	air tube adapter for ECS ⁵

*1 For AWG sizes refer to the conversion table on our homepage
www.schaltbau-gmbh.com/files/awg-electrical-wire-conversion-table.pdf

*2 Additional contacts. Module holder needed for assembly of additional adapter in connector shell.

*3 Please note that our charging connectors are designed to be fitted with air feed and water supply modules for use with electrolyte circulation and water refilling systems.

*4 When assembling additional adapters such as pilot contact, air tube, or multifunctional adapters, please note that the top mounted twin module holder can accommodate two adapters.

*5 ECS for electrolyte circulation system

 **Special Variants:**

If you need a special variant, please do not hesitate to contact us. Maybe the type of charging connector you are looking for is among our many special designs. If not, we can also supply customized designs. In this case, however, minimum ordering quantities apply.

 **Note:**

Presented in this catalogue are only stock items which can be supplied in short delivery time. For some variants minimum quantities apply. Please do not hesitate to ask for the conditions.

• **Dimension diagrams:**

The diagrams show the side and top view of the charging plug and battery receptacle.

For detailed information of the LV Series charging connector, refer to www.schaltbau-gmbh.com/files/a84_en.pdf

• **Charging plug** no module holder mounted, option W0

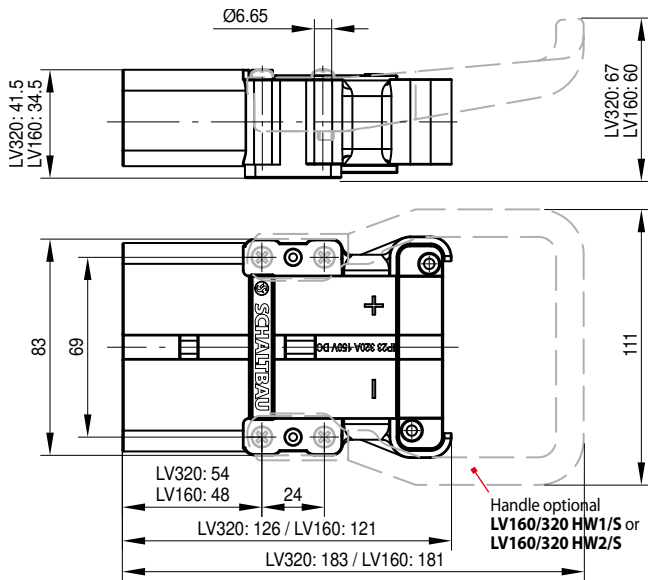

• **Battery receptacle** no module holder mounted, option W0

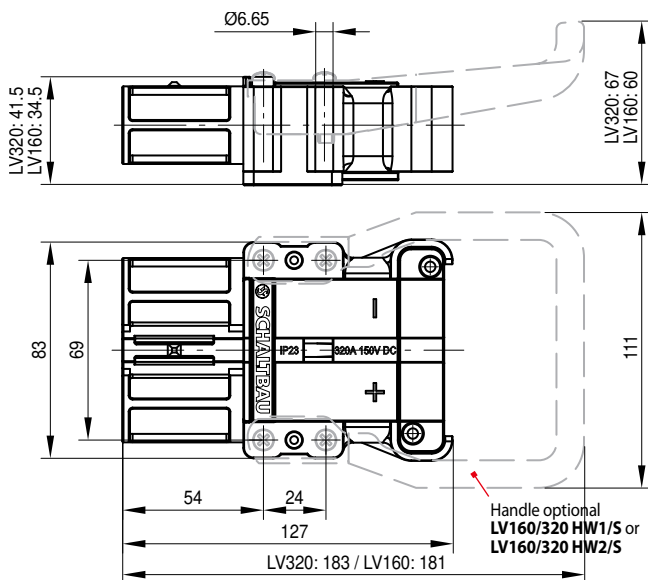

• **Mounting Options:**

Module holders are designed for accommodating multifunction adapters or additional pilot contact and air tube adapters. The twin module holder mounted on top of the plug or receptacle shell can hold two adapters.

• **Option W0** no module holder mounted

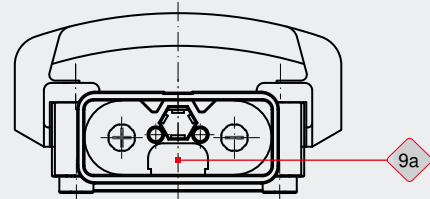

Plug shell without module holder

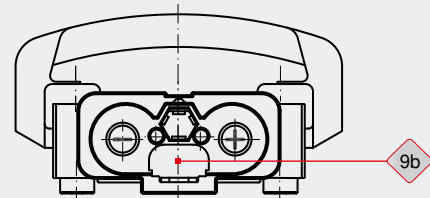

Receptacle shell without module holder

• **Option W1*** Twin module holder, mounted on top

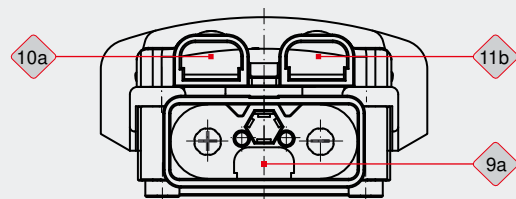

Plug shell with twin module holder

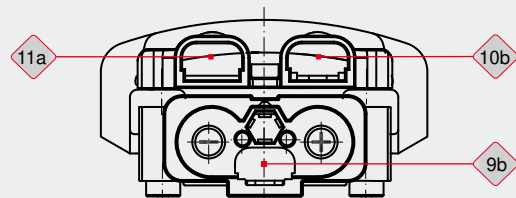

Receptacle shell with twin module holder

The figures show the mounting options of the adapters for the plug and receptacle shell and of the twin module holder respectively. The connector shell and module holder can be fitted with adapters 9a/9b, 10a/10b or 11a/11b, see opposite page for identification.

* Configuration W1 is interchangeable with REMA, APP and Proconnect type connectors and can be assembled with the module holders of these manufacturers. No warranty, however, due to lack of dimensional standardization!

Multifunctional adapters Individual components, Spare parts

Series LV160/LV320

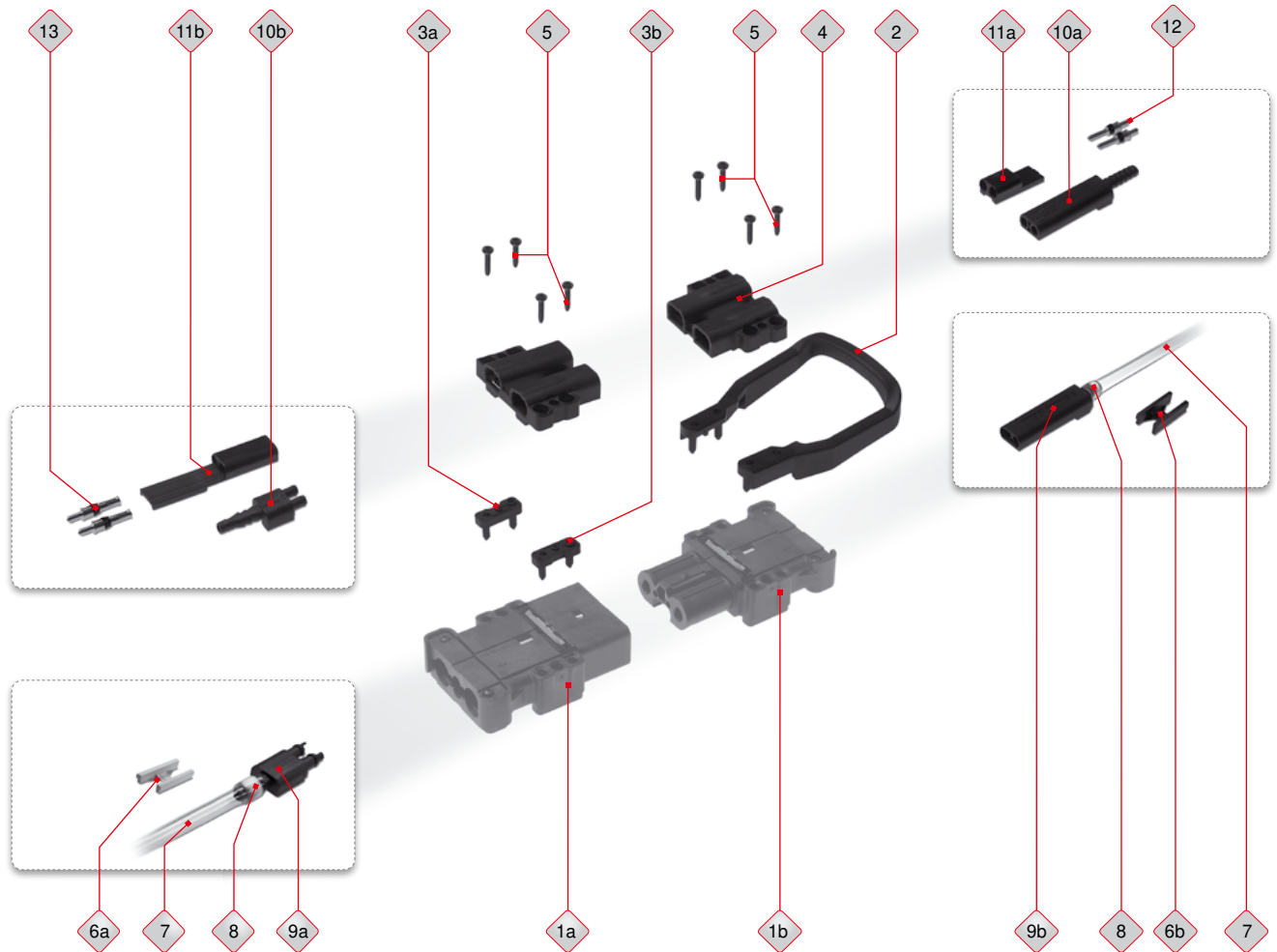

Item	Identification	Ordering code		Description
		LV160 Series	LV320 Series	
1a 1b	Plug shell Receptacle shell	LV160 x-Pxx-_-x-_-_- LV320 x-Sxx-_-x-_-_-	LV320 x-Pxx-_-x-_-_- LV320 x-Sxx-_-x-_-_-	Charging plug Battery receptacle } see configuration tool on homepage or catalogue A84.en
2	Handle (screw-on)	black red	LV160/320 HW1 LV160/320 HW2	screw-on handle for plug and receptacle shell
3a 3b	Spacer, marked L Spacer, marked R		LV160/320 MA-L LV160/320 MA-R	required for top mounting of twin module holder on connector used without handle
4	Twin module holder		LV160/320 MT-M	fits with adapters marked S and P resp.
5	Screw for top mounted twin module holder		SC 5.5x25	4x screw 5.5x25 for mounting the handle in combination with the twin module holder.
6a 6b	Spacer for multifunctional adapter	plug receptacle	LV160/320 DS-WP LV160/320 DS-WS	Spacer for securing of multifunctional adapter (Pos. 9a, 9b) in plug shell (Pos. 1a) and receptacle shell (Pos. 1b)
7	Tube		PVC tube 6x1.5	Tube 6 x 1.5, length 200 mm
8	Clamping ring		NW6	Clamping ring for securing connection of tube to multifunctional adapter, item 9a/9b
9a 9b	Multifunctional adapter,	marked P marked S	LV160/320 WK-P LV160/320 WK-S	for use with electrolyte circulation and water top up systems for tubes with inside diameter 6 mm
10a 10b	Air tube adapter,	marked P marked S	LV160/320 LV-P LV160/320 LV-S	for use with electrolyte circulation systems, for air feed tubes with inside diameter 6 mm
11a 11b	Pilot contact adapter,	marked P marked S	LV160/320 PA-P LV160/320 PA-SW	Insert for pin contacts Insert for socket contacts
12	Pilot contact, 2.5 mm ²	Pin	SCC-2.5-Ag	2x pilot contact for charging plug
13	Pilot contact, 2.5 mm ²	Socket	BCC-2.5-Ag	2x pilot contact for battery receptacle

Assembly Multifunctional, air tube, and pilot contact adapters

LV160/LV320 Series

Assembly in module holder:

- **Air tube adapter:** We recommend assembly of air tube adapter on ⊕ side of connector (plug shell: module holder marked P, receptacle shell: module holder marked S)
- **Pilot contact adapter:** always assemble on ⊖ side of connector (plug shell: module holder marked S, receptacle shell: module holder marked P), see figure below.

Where to assemble the adapters:

- **Pilot contact adapter:** on the ⊖ side of connector in module holder
- **Air tube adapter:** on the ⊕ side of connector in module holder
- **Multifunctional adapter*:** in the connector shell

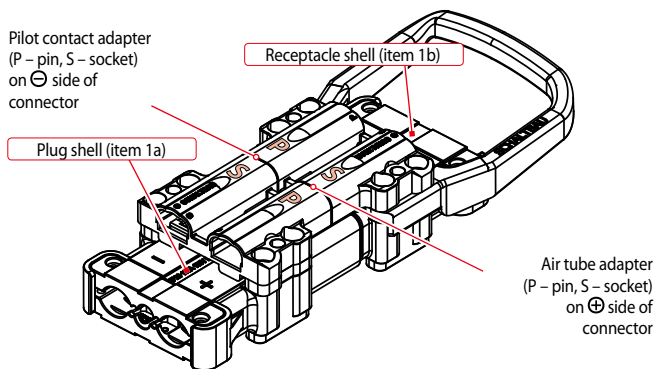

Assembly in connector shell:

- **Multifunctional adapters*:** are assembled without module holder directly in the connector shell.

* Multifunctional adapters are delivered pre-assembled with tube, size 6x1.5, length 200 mm, in connector shell 1a and 1b respectively.

Assembly of pilot contact and air tube adapter:

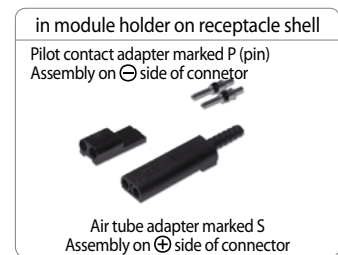
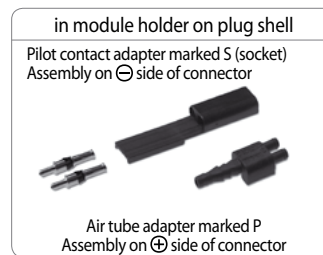

Multifunctional adapter*:



Installation and safety instructions

LV160/LV320 Series

The circular industrial connectors dealt with in this catalogue are intended for use with low-voltage systems and special installations. They are designed and tested in compliance with the generally recognised state of the art. However, the improper use, operation, handling, maintenance of or tampering with electric equipment can cause serious or fatal injury to the user or others, and the appliance or other property can be damaged.

Only authorized and trained personnel are allowed to plan and carry out all mechanical and electrical installations, transport, commissioning, as well as maintenance and repair work. This applies to the observation of the general installation and safety regulations for low-voltage systems as well as the proper use of tools approved for this purpose. Electric equipment requires protection from moisture and dust during installation, operation and storage.

i Due to our continuous improvement programme, the design of our products can be modified at any time. So some features may differ from the descriptions, specifications and drawings in the catalogue. You can download the latest update of the catalogue at schaltbau.info/download1en. The updated catalogue renders the previous issue invalid.

! **Electrical hazards: Any exposure to the connector's live parts. Risk of electrical shock!**
Observe all applicable national provisions, all safety, accident prevention and environmental regulations as well as the recognized technical rules for safe and proper working.

Disconnecting when live or under load

Disconnecting the connector when live or under load is generally only permitted under exceptional circumstances or in the case of imminent danger to operational safety according to EN 1175-1. Optional auxiliary contacts are available for switching off the load before disengaging the connector and switching on the load after engaging the connector, respectively. If the charging connector is used without auxiliary contacts the life of the main contacts can be considerably shortened because of contact welding when engaging or disengaging the connector.

LV80/160/320 Series: Inverse-polarity protection

In order to guarantee inverse-polarity protection the LV80/160/320 Series must always be fitted with a pilot contact adapter or an air tube adapter when intended for intermating with existing connectors of comparable design made by other manufacturers. Schaltbau, therefore, delivers LV80/160/320 Series stock items generally with a pilot contact adapter pre-assembled in the receptacle shell or an added air tube adapter with connectors for electrolyte circulation systems!

! When unmating the connector when live or under load, an arc is generated. That is why disconnecting under load is prohibited in the neighbourhood of explosives and other ignition sources.

i Inverse-polarity protection guaranteed when engaging connectors of the same LV Series.

Visual inspections

Be sure to make visual inspections regularly. Improper handling of the connector, e.g. when hitting the floor with some impact, can result in breakage, visible cracks and deformation.

! Defective and/or leaky parts must be replaced instantaneously!

Assembly instructions Module holder, adapters, handle, spacer

LV160/LV320 Series

Assembly of LV Series charging connector

Assemble the LV Series charging connector (item 1a, and 1b) using proper crimping tools. For assembly instructions please refer to manual: High power connectors for industrial trucks

➔ www.schaltbau-gmbh.com/files/a84-m_en.pdf

Multifunctional adapter (item 9a / 9b)

The multifunctional adapter comes pre-assembled in the plug shell (item 1a) and receptacle shell (item 1b) respectively with tube (item 7a) size 6 x 1.5 and length 200 mm, with mounted clamping ring and spacer.

Pilot contact adapter / air tube adapter

For assembly of item 10a/b, and 11a/b, refer to manual:

High power connectors for industrial trucks

➔ www.schaltbau-gmbh.com/files/a84-m_en.pdf

Assembly of adapters in module holder (item 4)

Insert pre-assembled pilot contact and air tube adapter resp. in module holder (item 4) until locked in place.

Always assemble air tube adapter on ⊕ side, and pilot contact adapter on ⊖ side of connector, see page 6.

Module holders are marked S and P and by a cast-in mould lettering of the ordering code. The same is true for the adapters.

Module holder mounted on	⊕ side of connector: Air tube adapter (item 10a/10b)	⊖ side of connector: Pilot contact adapter (item 11a/11b)
Plug shell	LV160/320 LV-P	LV160/320 PA-P
Receptacle shell	LV160/320 LV-S	LV160/320 PA-SW



Please see to it that you fit the adapter into the module holder with the matching label, see above table of reference.

Mounting of twin module holder (item 4)
• With handle:

Before mounting twin module holder (item 4, see also option W1 on page 4) snap handle onto connector shell. Place module holder on top of handle and tighten them together using the four screws (item 5).

• Without handle:

When connector is used without handle, spacers (item 3a and 3b) are required in place of the handle. Place module holder on top of spacers and tighten them together using the four screws (item 5).



We recommend fitting both the charging plug and the battery receptacle with handles.

Recommendation: We also recommend to fix the cables of the pilot and/or auxiliary contacts, as well as the air feed and/or water supply tubes to the cables of the main contacts by means of cable ties.



Please check that all cables and tubes are free from mechanical stress after assembly.

Installation and maintenance instructions LV Series

For a detailed list of all safety, installation and maintenance instructions, download our manual

➔ www.schaltbau-gmbh.com/files/a84-m_en.pdf

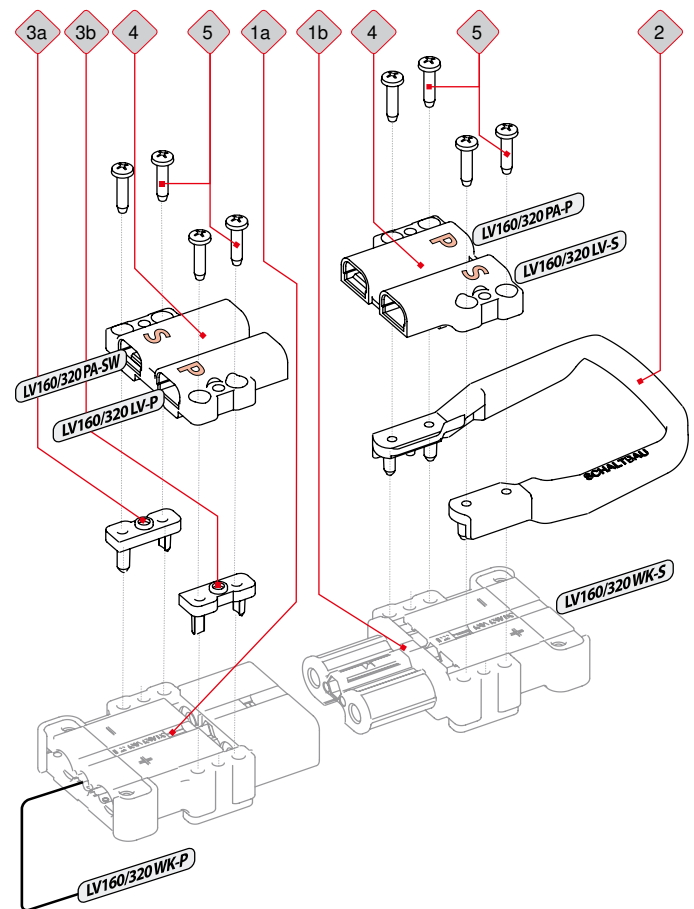
Tube marking



LV160/LV320 Series

General rule

Contents in tubes, pipes and containers shall be marked in colour with flow direction, danger symbol for labelling hazardous substances, and text.

Marking

Tubes connected to the charging connectors are to be marked thus:

Symbol	Description / Features
	Water top up, colour: GREY Connecting tube for multifunctional adapter
	Electrolyte circulation, colour: BLUE Connecting tube for multifunctional adapter or air tube adapter

How to order

Please order the appropriate tube marking for

- Water top up
- Electrolyte circulation

directly from

Stell GmbH
 Raiffeisenring 35-37
 46395 Bocholt
 Tel.: +49 28 71 70 02-0
 Fax: +49 28 71 70 02-72
 ➔ www.stell.de

Schaltbau GmbH

For detailed information on our products and services visit our website – or give us a call!

Schaltbau GmbH
Hollerithstrasse 5
81829 Munich
Germany



Phone +49 89 9 30 05-0
Fax +49 89 9 30 05-350
Internet www.schaltbau-gmbh.com
e-Mail contact@schaltbau.de

with compliments:



The production facilities of Schaltbau GmbH have been IRIS certified since 2008.



Certified to DIN EN ISO 14001 since 2002. For the most recent certificate visit our website.



Certified to DIN EN ISO 9001 since 1994. For the most recent certificate visit our website.

Electrical Components and Systems for Railway Engineering and Industrial Applications

Connectors

- Connectors manufactured to industry standards
- Connectors to suit the special requirements of communications engineering (MIL connectors)
- Charging connectors for battery-powered machines and systems
- Connectors for railway engineering, including UIC connectors
- Special connectors to suit customer requirements

Snap-action switches

- Snap-action switches with positive opening operation
- Snap-action switches with self-cleaning contacts
- Enabling switches
- Special switches to suit customer requirements

Contactors

- Single and multi-pole DC contactors
- High-voltage AC/DC contactors
- Contactors for battery powered vehicles and power supplies
- Contactors for railway applications
- Terminal bolts and fuse holders
- DC emergency disconnect switches
- Special contactors to suit customer requirements

Electrics for rolling stock

- Equipment for driver's cab
- Equipment for passenger use
- High-voltage switchgear
- High-voltage heaters
- High-voltage roof equipment
- Equipment for electric brakes
- Design and engineering of train electrics to customer requirements