

1

Connectors

M Series

Circular Modular
Connectors

Catalogue A10.en

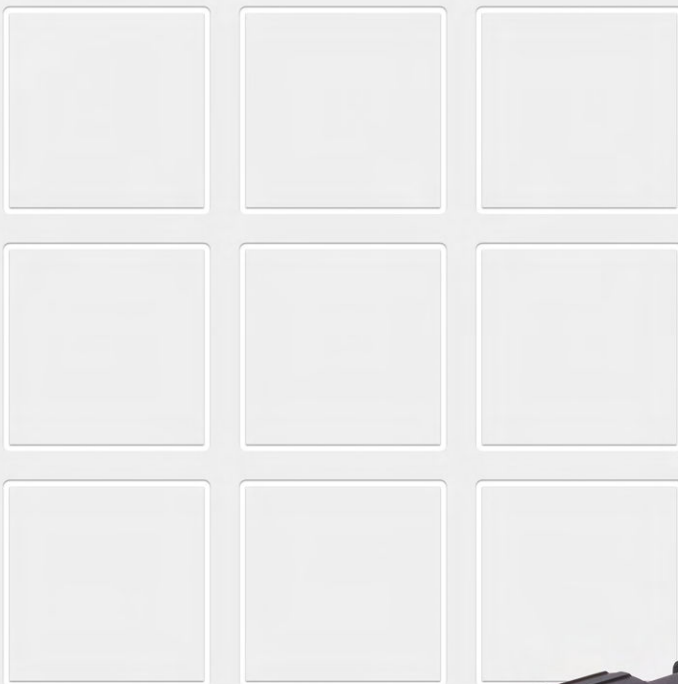

More information
schaltbau.com

Circular modular connectors: M1 and M3 Series

M1 and M3 Series universal industrial connectors are designed for safety and reliability also in harsh environments. Vibration, dust, aggressive liquids or vapours are often the cause of failures and serious safety problems. Sealed to IP67 or IP69K, our M1 and M3 Series circular connectors

are dustproof, pressure proof and water protected when mated. They are also largely resistant to the effects of most acids and alkalis as well as the extremes of temperature.

Features

M1, M3 series

The modular connector design allows many variations of assembly to fit your application:

Common features of M1 and M3 Series connectors:

- **Modular design:** Customized and cost-effective realisation of your application
- **Shells:** Various kinds of assembly, e.g. plug and receptacle shells with and without strain relief, with flange, for use with heat shrink boots or backshells with thread and cable gland, also flange-mount angled receptacle. Materials used:
 - Fibre glass reinforced polyamide: impact resistant
 - Non-halogen, UL listed.
- **Design flexibility:** Plug and receptacle shell can be fitted with either pin or socket insert, i.e. fully insulated socket inserts can be mounted on the live part.
- **Orientation:** Pin and socket inserts can be located in the shell in two different positions, thus preventing mismating. It also allows for the unmistakable connection of for example two connectors with different voltages to one and the same piece of equipment.
- **Contacts:**
 - High-quality screw machine contacts
 - Silver or gold plated
 - Crimp terminals for wire gauges from AWG20 ... AWG9 (0,5 ... 6 mm²)

Special features of M1 Series:

- Number of contacts: 4 and 6 + PE
- 5,000 mating cycles at constant low contact resistance
- Current rating: 16 A max.

Special features of M3 Series:

- Number of contacts: 6 + PE, 5+3 + PE, 12 + PE and 7+7 + PE
- 5,000 mating cycles at constant low contact resistance
- Current rating: 50 A max.

Configure the connector that suits your application

Inserts	Contacts	Shells	Accessories
M1 4 + PE	4x16 A	Receptacle with strain relief	Cable gland PG threaded
M1 6 + PE	6x16 A	Cable receptacle	Cable gland metric threaded
M3 6 + PE	6x32 A	Plug with strain relief	Protection cap for plugs
M3 5+3 + PE	5x16 A / 3x50 A	Flange plug	Protection cap for receptacles
M3 12 + PE	12x12 A	90° receptacle	Cable sleeve



Application

You can use our M1 and M3 Series connectors for various applications, especially where high reliability under harsh environmental conditions is important. Typical applications are: mining, ship-building, power plant construction, mechanical and traffic engineering, lighting engineering, environmental technology or food processing. We hold numerous official approvals.

Standards*

M1, M3 series

- IEC 61984** Connectors – Safety requirements and tests
- EN 60529** Ingress protection rating of enclosures (IP-Code)
- DIN 15560-104** Projectors for film and television studios, stage and photographic use – Part 104: Daylight projector systems up to 4.000 W rated power and special connectors
- UL 94-V0** Material flammability rating

Specifications

M1, M3 series

Series	M1			M3		
Number of contacts max.	4 + PE	6 + PE	6 + PE	5+3 + PE	12 + PE	7+7 + PE
Contact arrangement						
Contact identification as marked on insert: Pin insert: Rear view Socket insert: Front view						
Contacts / Identification						
as marked on insert: Pin insert: Rear view Socket insert: Front view	1 PE 4 2 3	1 PE 5 2 3 4	1 2 5 6 3 4 PE	5 6 7 8 4 2 3 1 PE	9 1 2 8 10 3 7 12 11 4 6 PE 5	9 1 2 8 13 10 14 3 7 12 11 4 6 PE 5
Rated voltage (IEC 60038) at Pollution Degree PD3 and altitude correction factor 1 (IEC 60664-1)	⊕ 230 V/400 V ⊕ Earth contact	⊕ 250 V ⊕ Earth contact	⊕ 230 V/400 V ⊕ Earth contact	⊕ 230 V/400 V ⊕ 25 V ⊕ Earth contact	⊕ 250 V ⊕ Earth contact	⊕ 250 V ⊕ 200 V ⊕ Earth contact
Orientations	2	2	2	2	2	2
Current rating of individual contact, max. *1 Type of contact *2:						
A Pin SAC-x / Socket BAC-x B Pin SBC-x / Socket BBC-x C Pin SCC-x / Socket BCC-x	A 4 x 16 A	A 6 x 16 A	B 6 x 32 A	A 5 x 16 A C 3 x 50 A	A 12 x 16 A	A 14 x 16 A
Current rating of individual contact: *3	A	A	B	A C	A	A
Wire gauge AWG20 (0.50 mm ²)	7.5 A	7.5 A	7.5 A	7.5 A ---	7.5 A	7.5 A
AWG18 ... 17 (0.75 ... 1.00 mm ²)	10 A	10 A	10 A	10 A ---	10 A	10 A
AWG15 (1.50 mm ²)	16 A	16 A	16 A	16 A ---	16 A	16 A
AWG13 (2.50 mm ²)	16 A	16 A	27.5 A	16 A 27.5 A	16 A	16 A
AWG11 (4.00 mm ²)	---	---	32 A	--- 35 A	---	---
AWG9 (6.00 mm ²)	---	---	35 A	--- 50 A	---	---
Contact resistance (IEC 60512-2)	<3 mΩ					
Insulation resistance (IEC 60512-3)	1 GΩ					
Range of operating temperature *4	-50°C ... +100°C					
IP rating (IEC 60529 – IP code) when mated/ unmated only with closed protection cap	IP67, IP69K					
Mechanical endurance ,mating cycles (IEC 60512-9, test 9a)	5,000					
Shells Material / colour Inserts / colour Seals / colour Flammability rating (UL 94-V0)	PA6.6 GF30 non-halogen / black PA6.6 GF30 non-halogen / black NBR, CR / black ●					
Contacts Material Finish Terminals	Copper wrought alloy Ag / Au Crimp					
Approvals						











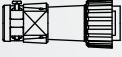





*1 Dependent on wire gauge and operating temperature, see »Derating diagrams«, page 19

*2 See »Inserts«, M1 Series, page 12 / M3 Series, page 17

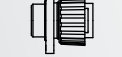





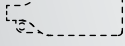



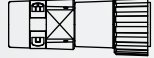

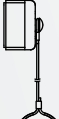







*3 See »Contacts«, page 18

*4 Operating temperatures exceeding 25°C account for lower rated current values, see derating diagrams on page 19













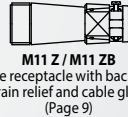

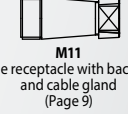

M1 Plug

Cable gland	Shell part 2	Shell part 1	Contact	Insert	Protection cap
	 T1-x Cable sleeve (Page 11)	 M16 Z / M16 ZB Cable plug with backshell, strain relief and cable gland (Page 8)	 SAC-x.xx-yy Pin contact (Page 18)	 M1 E-4P+PE Pin insert (Page 11)	 M1 KS Protection cap for plugs (Page 11)
 M1 Pg13,5 10-12 Cable gland Pg13.5 (Page 10)	 M1 Pg13,5 Backshell Pg13.5 (Page 10)	 M16 Cable plug with backshell and cable gland (Page 8)	 BAC-x.xx-yy Socket contact (Page 18)	 M1 E-4S+PE Socket insert (Page 11)	
 M1 VM20 8-13 Cable gland M20x1,5 (Page 10)	 M1 M20 Backshell M20x1,5 (Page 10)	 M15 Flange plug (Page 8)	 BS-A-V10 Filler plug (Page 18)	 M1 E-6P+PE Pin insert (Page 11)	 M1 K Protection cap for plugs (Page 11)
	 222K142-15 Shrink boot, 90° (Page 11)	 M16 W Threaded plug for use with backshell/shrink boot (Page 8)		 M1 E-6S+PE Socket insert (Page 11)	
	 202K142-15 Shrink boot, straight (Page 11)				













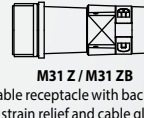









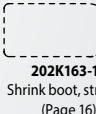

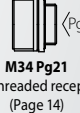
M3 Plug

Cable gland	Shell part 2	Shell part 1	Contact	Insert	Protection cap
	 T28-x Cable sleeve (Page 16)	 M36 Z / M3 36ZB Cable plug with backshell, strain relief and cable gland (Page 13)	 SAC-x.xx-yy Pin contact (Page 18)	 M3 E-6P+PE Pin insert (Page 17)	 M3 KS Protection cap for plugs (Page 16)
	 222K142-15 Shrink boot, 90° (Page 16)	 M35 Flange plug (Page 13)	 BAC-x.xx-yy Socket contact (Page 18)	 M3 E-6S+PE Socket insert (Page 17)	
	 202K163-15 Shrink boot, straight (Page 16)	 M36 W Threaded plug for use with backshell/shrink boot (Page 13)	 BS-A-V10 Filler plug (Page 18)	 M3 E-5P+3P+PE Pin insert (Page 17)	 M3 K Protection cap for plugs (Page 16)
 M3 VPg21 14-18 Cable gland Pg21 (Page 15)	 M3 Pg21 Backshell Pg21 (Page 15)			 M3 E-5S+3S+PE Socket insert (Page 17)	
 M3 VM25 11-17 Cable gland M25x1,5 (Page 15)	 M3 M25 Backshell M25x1,5 (Page 15)			 M3 E-12P+PE Pin insert (Page 17)	
				 M3 E-12S+PE Socket insert (Page 17)	
				 M3 E-7P+7P+PE Pin insert (Page 17)	
				 M3 E-7S+7S+PE Socket insert (Page 17)	

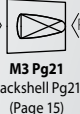
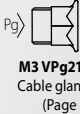
M1 Receptacle

Protection cap	Insert	Contact	Shell part 1	Shell part 2	Cable gland
 M1 DS Protection cap for receptacles (Page 11)	 M1 E-4P+PE Pin insert (Page 12)	 SAC-x.xx-yy Pin contact (Page 18)	 M11 Z / M11 ZB Cable receptacle with backshell, strain relief and cable gland (Page 9)	 T1-x Cable sleeves (Page 11)	
	 M1 E-4S+PE Socket insert (Page 12)	 BAC-x.xx-yy Socket insert (Page 18)	 M11 Cable receptacle with backshell and cable gland (Page 9)		
 M1 D Protection cap for receptacles (Page 11)	 M1 E-6P+PE Pin insert (Page 12)	 BS-A-V10 Filler plug (Page 18)	 M14 Pg13,5 Pg13.5 threaded receptacle (Page 9)		
	 M1 E-6S+PE Socket insert (Page 12)			 M14 M20 M20x1.5 threaded receptacle (Page 9)	 M1 M20D Backshell M20x1.5 (Page 10)
			 M13 Flange mount receptacle (Page 9)		
			 M18 Flange mount angled receptacle (Page 10)		

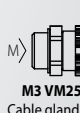
M3 Receptacle

Protection cap	Insert	Contact	Shell part 1	Shell part 2	Cable gland
 M3 DS Protection cap for receptacles (Page 16)	 M3 E-6P+PE Pin insert (Page 17)	 SAC-x.xx-yy SBC-x.xx-yy SCC-x.xx-yy Pin contact (Page 18)	 M31 Z / M31 ZB Cable receptacle with backshell, strain relief and cable gland (Page 14)	 T28-x Cable sleeve (Page 16)	
	 M3 E-6S+PE Socket insert (Page 17)	 BAC-x.xx-yy BBC-x.xx-yy BCC-x.xx-yy Socket contact (Page 18)	 M33 Flange mount receptacle (Page 14)	 222K142-15 Shrink boot, 90° (Page 16)	
 M3 D Protection cap for receptacles (Page 16)	 M3 E-5P+3P+PE Pin insert (Page 17)	 BS-A-V10 BS-B-V10 BS-C-V10 Filler plug (Page 18)	 M33 W Receptacle for use with shrink boot (Page 14)	 202K163-15 Shrink boot, straight (Page 16)	
	 M3 E-5S+3S+PE Socket insert (Page 17)			 M34 Pg21 Pg21 threaded receptacle (Page 14)	 M3 Pg16 Backshell Pg16 (Page 15)
	 M3 E-12P+PE Pin insert (Page 17)		 M34 M30 M30x1.5 threaded receptacle (Page 14)	 M3 Pg21 Backshell Pg21 (Page 15)	 M3 VPg21 14-18 Cable gland Pg21 (Page 15)
	 M3 E-12S+PE Socket insert (Page 17)		 M38 Flange mount angled receptacle (Page 15)	 M3 M25D Backshell M25x1.5 (Page 15)	 M3 VM25 11-17 Cable gland M25x1.5 (Page 15)
	 M3 E-7P+7P+PE Pin insert (Page 17)				
	 M3 E-7S+7S+PE Socket insert (Page 17)				

How to order











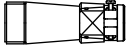
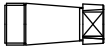

M1, M3 series

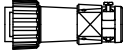
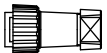
Our M1 and M3 Series connectors consist of various components which you can order individually, thus assembling a connector that suits your application to a T.

Our "Overview" on pages 4 and 5 will help you with the details of the

assembly. The following table is a summary of all available individual components of our M1 and M3 Series connectors.

Please note that according to our price list minimum order quantities apply. For orders below that minimum our distributors will be at your service.

Item	Depiction	Ordering code		Brief description
		M1	M3	
Shell Part 1 Receptacles		M11 Z M11 ZB	M31 Z M31 ZB	Cable receptacle with backshell, strain relief and cable gland ZB: Kit of loosely packed components
		M11	---	Cable receptacle with backshell and cable gland
		M13	M33	Flange mount receptacle
		---	M33 W	Receptacle for use with shrink boot
		M14 Pg13.5 M14 M20	M34 Pg21 M34 M30	PG threaded receptacle for use with PG threaded backshell Metric threaded receptacle for use with metric threaded backshell
		M18	M38	Flange mount angled receptacle
Shell Part 1 Plugs		M16 Z M16 ZB	M36 Z M36 ZB	Cable plug with strain relief ZB: Kit of loosely packed components
		M16	---	Cable plug with cable gland
		M16 W	M36 W	PG threaded plug for use with PG threaded backshell or shrink boot
		M15	M35	Flange plug
Shell Part 2 Backshells, cable sleeves/ seals		202K142-15 (Raychem)	202K163-15 (Raychem)	Shrink boot, straight (order direct from Raychem or other OEMs)
		222K142-15 (Raychem)	222K163-15 (Raychem)	Shrink boot, 90° (order direct from Raychem or other OEMs)
		M1 Pg13.5 *1	M3 Pg16 M3 Pg21	Backshell with PG threaded front and rear skirt *1 Use only if configured as a plug
		M1 M20 *1	M3 M25	Backshell with PG threaded front skirt and metric threaded rear skirt *1 Use only if configured as a plug
		M1 M20D	M3 M25D	Backshell with PG threaded front skirt and metric threaded rear skirt
	T1-4/6 T1-6/8 T1-8/10 T1-10/12 T1-12/13 T1-14.5	T28-10/13 T28-13/16 T28-16/18.5 T28-18.5/20.5 T28-20.5/22 ---	Cable-Ø T1 (M1) 4 ... 6 mm 6 ... 8 mm 8 ... 10 mm 10 ... 12 mm 12 ... 13 mm 14 ... 15 mm T28 (M3) 10 ... 13 mm 13 ... 16 mm 16 ... 18,5 mm 18,5 ... 20,5 mm 20,5 ... 22 mm ---	
Cable glands	 	M1 VPg13.5 10-12 *1	M3 VPg21 14-18	PG threaded cable gland *1 Use only if configured as a plug
		M1 VM20 8-13	M3 VM25 11-17	Metric threaded cable gland

(continued on page 7)

Subject to change

(Continued from page 6)

Item	Depiction	Ordering code		Brief description
		M1	M3	
Protection caps		M1 KS M1 DS	M3 KS M3 DS	Protection cap with cord for plugs Protection cap with cord for receptacles
		M1 K M1 D	M3 K M3 D	Protection cap with plastic strap for plugs Protection cap with plastic strap for receptacles
Inserts		M1 E-4P+PE M1 E-4S+PE	--- ---	4 + PE pin insert for contacts SAC-x / PE: BAC-x 4 + PE socket insert for contacts BAC-x / PE: SAC-x
		M1 E-6P+PE M1 E-6S+PE	--- ---	6 + PE pin insert for contacts SAC-x / PE: BAC-x 6 + PE socket insert for contacts BAC-x / PE: SAC-x
		--- ---	M3 E-6P+PE M3 E-6S+PE	6 pole+ PE pin insert for contacts SBC-x / PE: BBC-x 6 pole+ PE socket insert for contacts BBC-x / PE: SBC-x
		--- ---	M3 E-5P+3P+PE M3 E-5S+3S+PE	5+3 + PE pin insert for contacts SCC-x, SAC-x / PE: BCC-x 5+3 pole+ PE socket insert for contacts BCC-x, BAC-x / PE: SCC-x
		--- ---	M3 E-12P+PE M3 E-12S+PE	12 + PE pin insert for contacts SAC-x / PE: BAC-x 12 + PE socket insert for contacts BAC-x / PE: SAC-x
		--- ---	M3 E-7P+7P+PE M3 E-7S+7S+PE	7+7 + PE pin insert for contacts SAC-x / PE: BAC-x 7+7 + PE socket insert for contacts BAC-x / PE: SAC-x
Contacts Type A		SAC-0.50-Ag SAC-1.00-Ag SAC-1.50-Ag SAC-2.50-Ag	SAC-0.50-Ag SAC-1.00-Ag SAC-1.50-Ag SAC-2.50-Ag	Wire gauge AWG20 (0.50 mm ²) AWG18 ... 17 (0.75 ... 1.00 mm ²) AWG15 (1.50 mm ²) AWG13 (2.50 mm ²)
		BAC-0.50-Ag BAC-1.00-Ag BAC-1.50-Ag BAC-2.50-Ag	BAC-0.50-Ag BAC-1.00-Ag BAC-1.50-Ag BAC-2.50-Ag	AWG20 (0.50 mm ²) AWG18 ... 17 (0.75 ... 1.00 mm ²) AWG15 (1.50 mm ²) AWG13 (2.50 mm ²)
		BS-A-V10	BS-A-V10	Filler plug for unused contact cavities
Contacts Type B		---	SBC-0.50-Ag	Wire gauge AWG20 (0.50 mm ²)
		---	SBC-1.00-Ag	AWG18 ... 17 (0.75 ... 1.00 mm ²)
		---	SBC-1.50-Ag	AWG15 (1.50 mm ²)
		---	SBC-2.50-Ag	AWG13 (2.50 mm ²)
		---	SBC-4.00-Ag	AWG11 (4.00 mm ²)
	---	BBC-0.50-Ag	AWG20 (0.50 mm ²)	
	---	BBC-1.00-Ag	AWG18 ... 17 (0.75 ... 1.00 mm ²)	
	---	BBC-1.50-Ag	AWG15 (1.50 mm ²)	
	---	BBC-2.50-Ag	AWG13 (2.50 mm ²)	
	---	BBC-4.00-Ag	AWG11 (4.00 mm ²)	
	---	BBC-6.00-Ag	AWG9 (6.00 mm ²)	
		---	BS-B-V10	Filler plug for unused contact cavities
Contacts Type C		---	SCC-2.50-Ag	Wire gauge AWG13 (2.50 mm ²)
		---	SCC-4.00-Ag	AWG11 (4.00 mm ²)
		---	SCC-6.00-Ag	AWG9 (6.00 mm ²)
		---	BCC-2.50-Ag	AWG13 (2.50 mm ²)
		---	BCC-4.00-Ag	AWG11 (4.00 mm ²)
---		BCC-6.00-Ag	AWG9 (6.00 mm ²)	
	---	BS-C-V10	Filler plug for unused contact cavities	

The default contact finish for pin and socket contacts is silver. For gold plated contacts change 'Ag' to 'Au' in the ordering code.

i Note:
Presented in this catalogue are only stock items which can be supplied in short delivery time. For some variants minimum quantities apply. Please do not hesitate to ask for the conditions..

i Special variants:
If you need a special variant, please do not hesitate to contact us. Maybe the type of connector you are looking for is among our many special designs. If not, we can also supply customized designs. In this case, however, minimum ordering quantities apply.

M16 Z, M16 ZB, M16, M15, M16 W Plug shells, Part 1

M1 series

- **M16 Z, M16 ZB** Cable plug with backshell, strain relief and cable gland

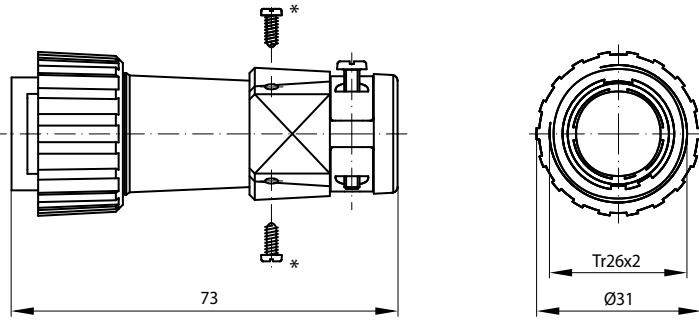

Ordering code	Description
M16 Z	Cable plug with backshell, strain relief and cable gland**
M16 ZB	Kit M16 Z All components loosely packed**

Note:

* To prevent the strain relief from loosening use two self-tapping cylinder head screws 2.2 x 9.5 (not included in delivery)

** Cable sleeve T1-x required
All M1 inserts can be used with these plugs

- **M16** Cable plug with backshell and cable gland

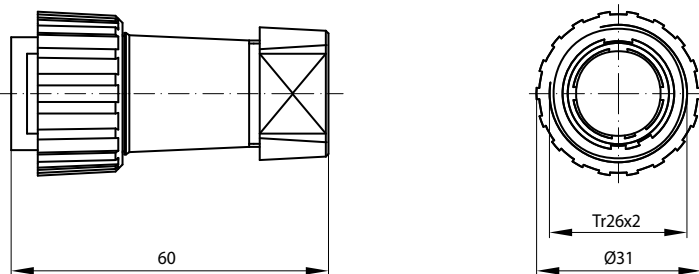

Ordering code	Description
M16	Plug with backshell and cable gland**

Note:

** Cable sleeve T1-x required
All M1 inserts can be used with this plug

- **M15** Flange plug

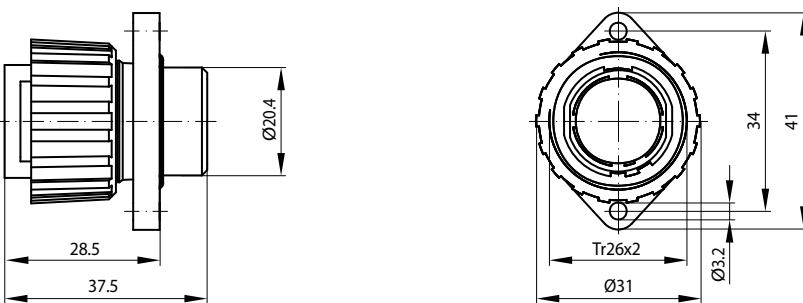

Ordering code	Description
M15	Flange plug

Note:

- All M1 inserts can be used with this plug
- Mounted with M3 screws, torque 2.5 Nm.

- **M16 W** Plug with threaded rear skirt (for use with backshell or shrink boot)

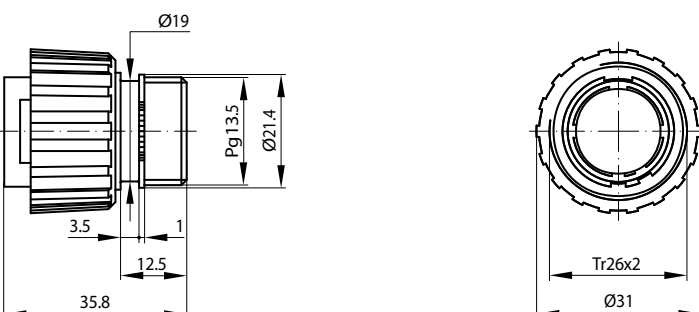

Ordering code	Description
M16 W	Plug with threaded rear skirt for use with backshell M1 Pg13,5 and M1 M20 or shrink boot

Note:

- All M1 inserts can be used with this plug
- Plug can also be box mounted, torque 2.5 Nm.

M11 Z, M11 ZB, M11, M13, M14 xx Receptacle shells, Part 1

M1 series

- **M11 Z, M11 ZB** Cable receptacle with backshell, strain relief and cable gland

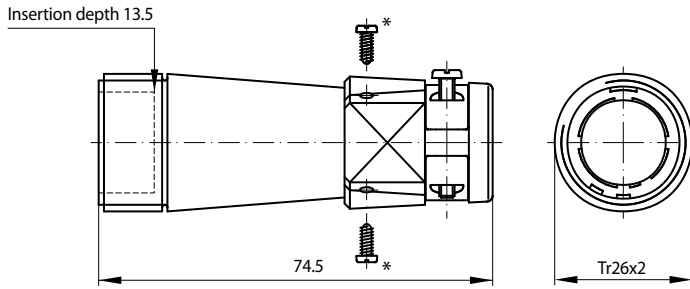

Ordering code	Description
M11 Z	Cable receptacle with back-shell, strain relief and cable gland**
M11 ZB	Kit M11Z All components loosely packed**

Note:

* To prevent the strain relief from loosening use two self-tapping cylinder head screws 2.2 x 9.5 (not included in delivery)

** Cable sleeve T1-x required
All M1 inserts can be used with these receptacles

- **M11** Cable receptacle with backshell and with cable gland

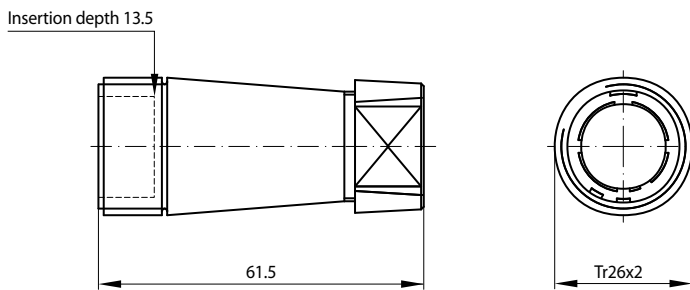

Ordering code	Description
M11	Cable receptacle with back-shell and cable gland**

Note:

** Cable sleeve T1-x required
All M1 inserts can be used with this receptacle

- **M13** Flange mount receptacle

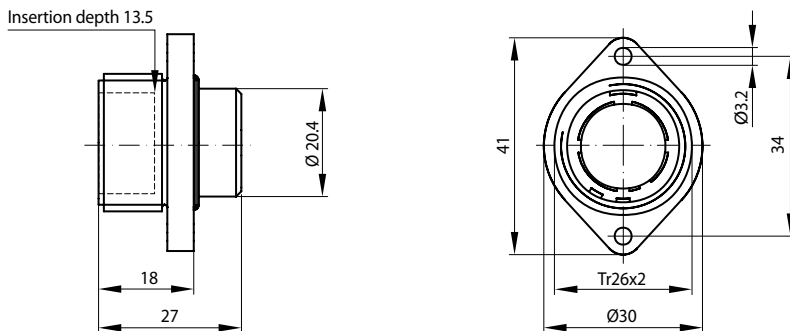

Ordering code	Description
M13	Flange mount receptacle

Note:

- All M1 inserts can be used with this receptacle
- Mounted with M3 screws, torque 2.5 Nm.

- **M14 Pg13,5, M14 M20** Receptacle with threaded rear skirt (for use with backshell)

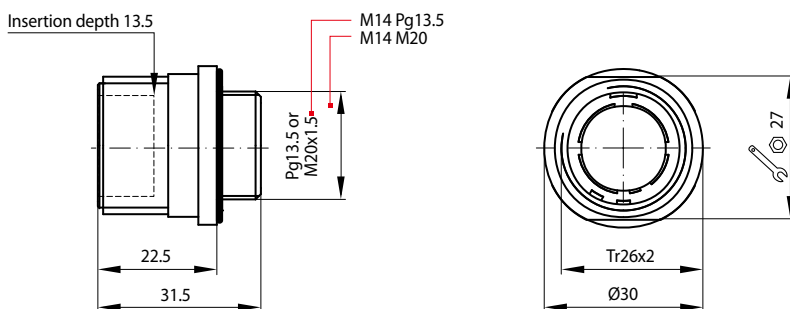

Ordering code	Description
M14 Pg13,5	Receptacle with Pg13.5 threaded rear skirt
M14 M20	Receptacle with M20x1.5 threaded rear skirt for use with backshell M1 M20D

Note:

- All M1 inserts can be used with these receptacles
- Receptacle can also be box mounted, torque 2.5 Nm.

M18 Receptacle shells, Part 1 (continued)

M1 series

• **M18** Flange mount angled receptacle

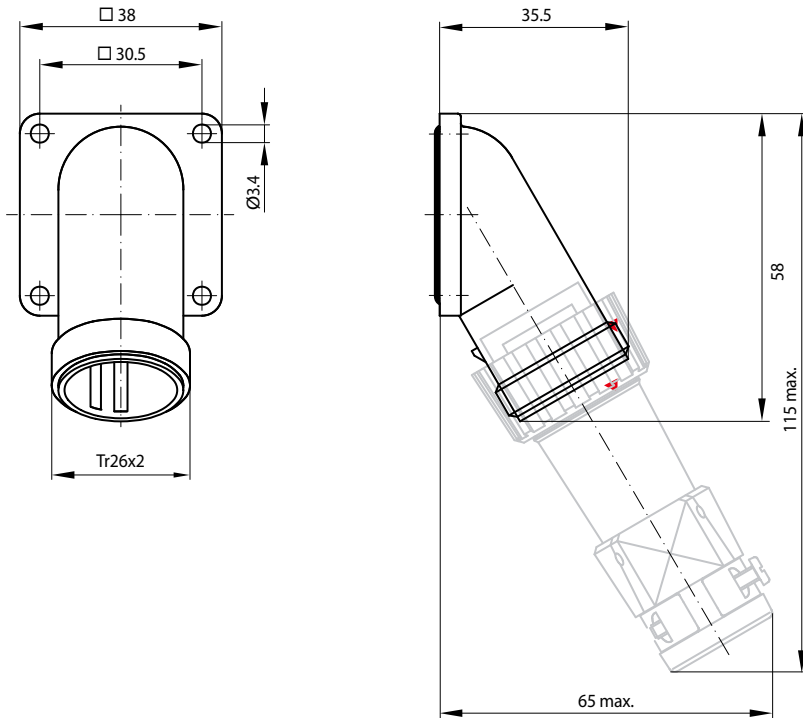

Ordering code	Description
M18	Flange mount angled receptacle

Note:

- All M1 inserts can be used with this receptacle

M1 Pg13,5, M1 M20, M1 M20D Backshells, Part 2

M1 VPg13,5..., M1 VM20... Cable glands

M1 series

• **M1 Pg13,5** Pg13.5 threaded backshell

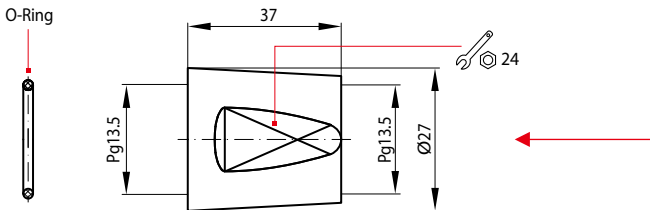

Ordering code	Description
M1 Pg13,5	Backshell with Pg13.5 threaded front and rear skirt for use with plug M16W

• **M1 VPg13,5 10-12** Pg13.5 threaded cable gland

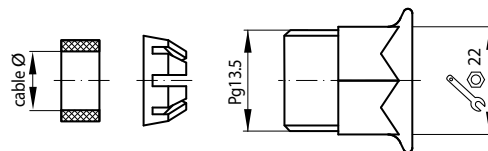

Ordering code	Description
M1 VPg13,5 10-12	Pg13.5 threaded cable gland for use with backshell M1 Pg13.5

• **M1 M20, M1 M20D** M20x1.5 threaded backshell

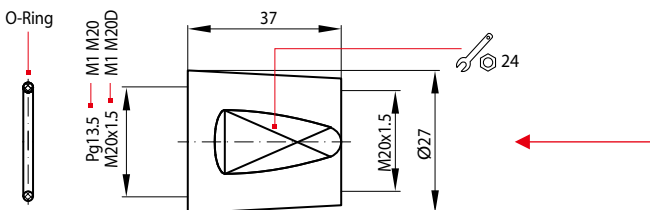

Ordering code	Description
M1 M20	Backshell with Pg13.5 threaded front skirt and M20x1.5 threaded rear skirt for use with plug M16W
M1 M20D	Backshell with M20x1.5 threaded front and rear skirt for use with receptacle M14 M20

• **M1 VM20 8-13** M20x1.5 threaded cable gland

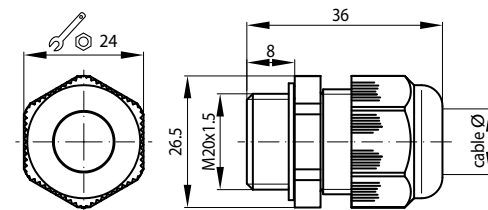

Ordering code	Description
M1 VM20 8-13	M20x1.5 threaded cable gland for use with backshell M1 M20 and M1 M20D

T1-xx/xx Cable sleeves/seals, Shells Part 2

M1 series

- **T1-4/6, ..., T1-12/13** Cable sleeve, Fig. A

T1-4/6
T1-6/8
T1-8/10
T1-10/12
T1-12/13

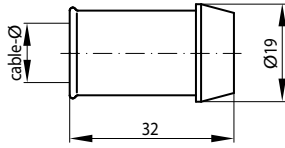

- **T1-14.5** Sealing ring, Fig. B

T1-14.5

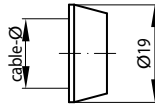

Ordering code	Fig.	Description
T1-4/6	A	cabl-Ø 4 ... 6 mm
T1-6/8	A	cabl-Ø 6 ... 8 mm
T1-8/10	A	cabl-Ø 8 ... 10 mm
T1-10/12	A	cabl-Ø 10 ... 12 mm
T1-12/13	A	cabl-Ø 12 ... 13 mm
T1-14.5	B	cabl-Ø 14 ... 15 mm

Note:

- For use with M16, M16 Z, M16 ZB Series cable plugs
- For use with M11, M11 Z, M11 ZB Series cable receptacles

222K142-15, 202K142-15 Shrink boots, Shells Part 2

M1 series

- **222K142-15** Shrink boot, 90°

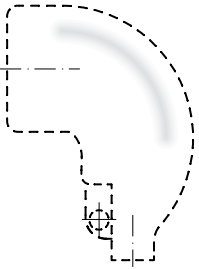

- **202K142-15** Shrink boot, straight

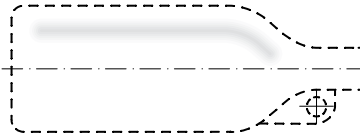

Ordering code	Description
222K142-15 *	Shrink boot, 90°
202K142-15 *	Shrink boot, straight

Note:

- For use with M16 W Series plug
- Cable diameter Ø 7.1 mm min.
- * Order direct from Raychem

M1 KS, M1 K Protection caps for plugs

M1 DS, M1 D Protection caps for receptacles

M1 series

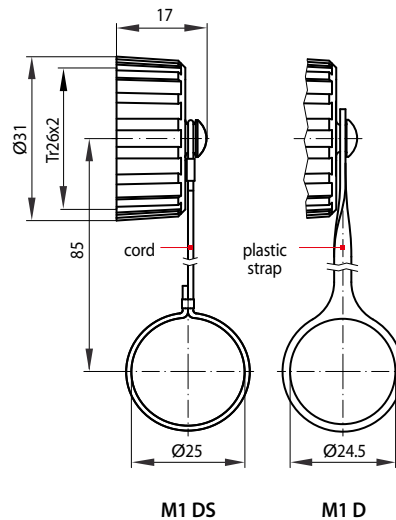
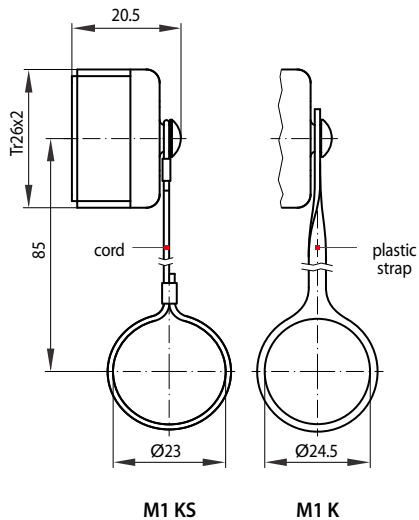

Ordering code	Description
M1 KS	Protection cap with cord for plugs
M1 K	Protection cap with plastic strap for plugs

Ordering code	Description
M1 DS	Protection cap with cord for receptacles
M1 D	Protection cap with plastic strap for receptacles

M1 E-4P+PE, M1 E-6P+PE Pin inserts 4 and 6 pole + PE
M1 E-4S+PE, M1 E-6S+PE Socket inserts 4 and 6 pole + PE

M1 series

• Pin insert M1 E-4P+PE

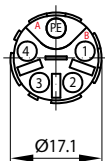
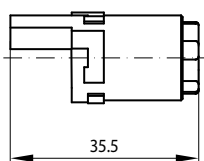

① ... ④ 4x Pin SAC-x
Ⓟ 1x Socket BAC-x

• Socket insert M1 E-4S+PE

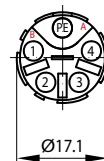
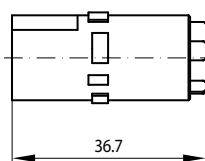

① ... ④ 4x Socket BAC-x
Ⓟ 1x Pin SAC-x

• Pin insert M1 E-6P+PE

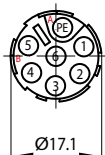
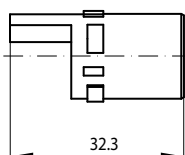

① ... ⑥ 6x Pin SAC-x
Ⓟ 1x Socket BAC-x

• Socket insert M1 E-6S+PE

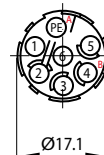
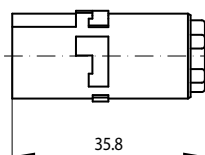

① ... ⑥ 6x Socket BAC-x
Ⓟ 1x Pin SAC-x

M1 Series: Number of contacts, max.		4 + PE	6 + PE
Ordering code	Pin insert Socket insert	M1 E-4P+PE M1 E-4S+PE	M1 E-6P+PE M1 E-6S+PE
Contact arrangement			
Contact identification as marked on insert:			
Pin insert:	Rear view		
Socket insert:	Front view		
Rated voltage (IEC 60038) At pollution degree PD3 (IEC 60512)		230 V / 400 V	250 V
Orientations		2 (A, B)	2 (A, B)
Contacts			
Current rating of individual contacts, max.*1		4x 16 A	6x 16 A
Contact diameter		Ø 1.58 mm	Ø 1.58 mm
Contact Type*2	Pin insert Socket insert	Pins SAC-x / PE socket BAC-x Sockets BAC-x / PE pin SAC-x	Pins SAC-x / PE socket BAC-x Sockets BAC-x / PE pin SAC-x

*1 Depending on wire gauge (see »Specifications«, page 3) as well as operating temperature (see »Derating diagrams«, page 19)

*2 For a detailed description see »Contacts«, page 18



Note:

Empty cavities should be fitted with filler plugs. See also page 18.

M36 Z, M36 ZB, M36, M35, M36 W Plug shells, Part 1

M3 series

- **M36 Z, M36 ZB** Cable plug with backshell, strain relief and cable gland

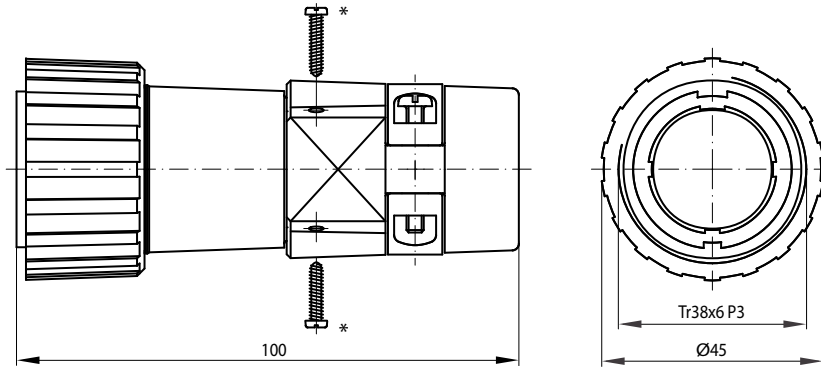

Ordering code	Description
M36 Z	Cable plug with backshell, strain relief and cable gland**
M36 ZB	Kit M36 Z All components loosely packed.**

Note:

- * To prevent the strain relief from loosening use two self-tapping cylinder head screws 2.9x 13 (not included in delivery)
- ** Cable sleeve T28-x required
All M3 inserts can be used with these plugs

- **M35** Flange plug

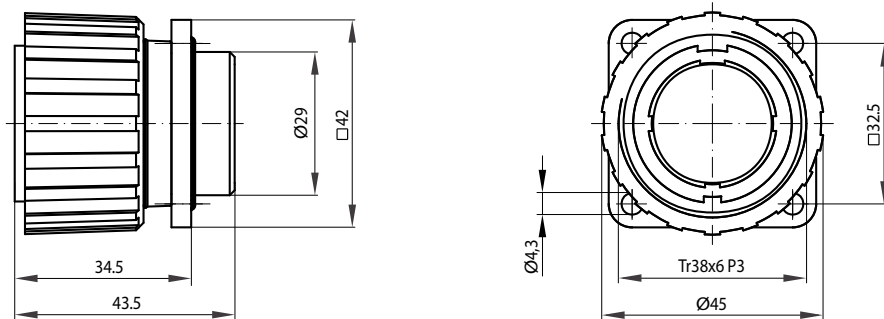

Ordering code	Description
M35	Flange plug

Note:

- All M3 inserts can be used with this plug
- Mounted with M4 screws, torque 2.5 Nm.

- **M36 W** Plug with threaded rear skirt (for use with backshell or shrink boot)

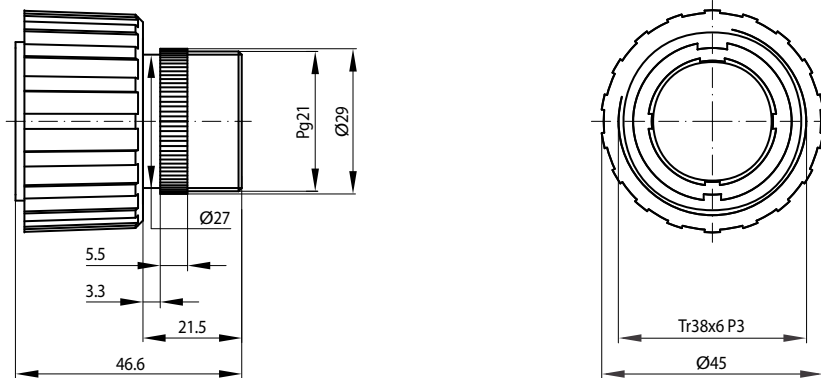

Ordering code	Description
M36 W	Plug with threaded rear skirt for use with backshells M3 Pg16, M3 Pg21, M3 M25, or shrink boot

Note:

- All M3 inserts can be used with this plug
- Plug can also be box mounted, torque 2.5 Nm.

M31 Z, M31 ZB, M33, M33 W, M34 xx Receptacle shells, Part 1

M3 series

● **M31 Z, M31 ZB** Cable receptacle with backshell, strain relief and cable gland

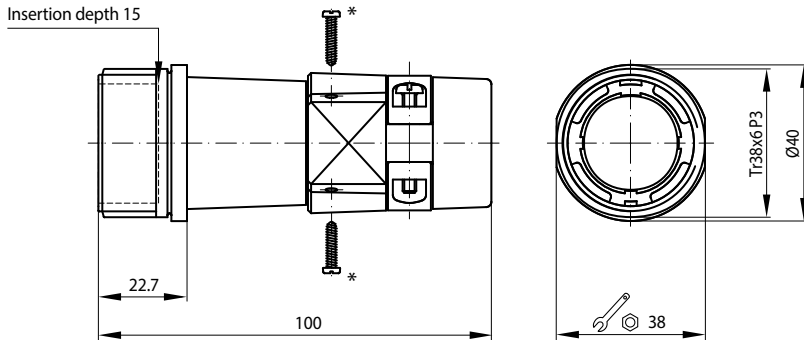

Ordering code	Description
M31 Z	Cable receptacle with back-shell, strain relief and cable gland**
M31 ZB	Kit M31 Z All components loosely packed.**

Note:

* To prevent the strain relief from loosening use two self-tapping cylinder head screws 2.9x 13 (not included in delivery)

** Cable sleeve T28-x required

All M3 inserts can be used with these receptacles

● **M33** Flange mount receptacle

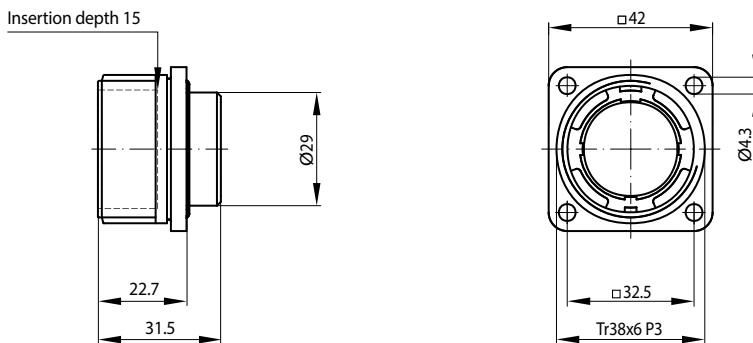

Ordering code	Description
M33	Flange mount receptacle

Note:

- All M3 inserts can be used with this receptacle
- Mounted with M4 screws, torque 2.5 Nm.

● **M33 W** Receptacle for use with shrink boot

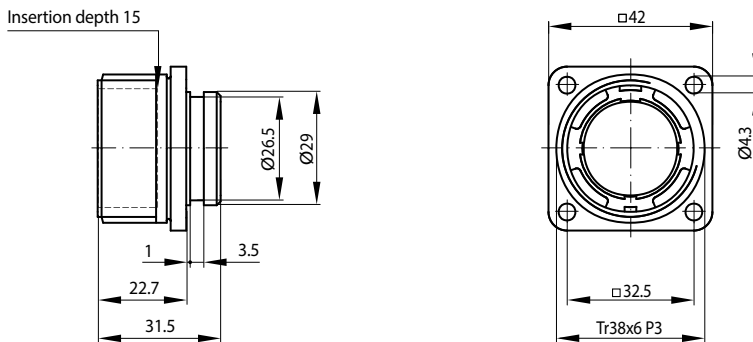

Ordering code	Description
M33 W	Receptacle for use with shrink boot

Note:

- All M3 inserts can be used with this receptacle

● **M34 Pg21, M34 M30** Receptacle with Pg21 or M30x1.5 threaded rear skirt

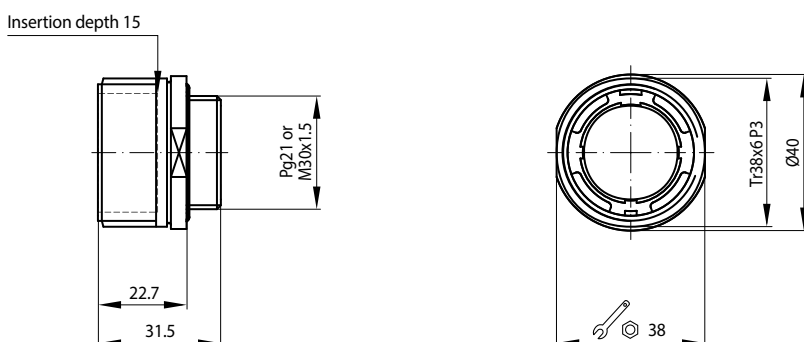

Ordering code	Description
M34 Pg21	Receptacle with Pg21 threaded rear skirt for use with: backshell M3 Pg16 backshell M3 Pg21 backshell M3 M25D
M34 M30	Receptacle with M30x1.5 threaded rear skirt for use with backshell M3 M25D

Note:

- All M3 inserts can be used with these receptacles
- Receptacle can also be box mounted, torque 2.5 Nm.

M38 Receptacle shells, Part 1 (continued)

M3 series

• **M38** Flange mount angled receptacle

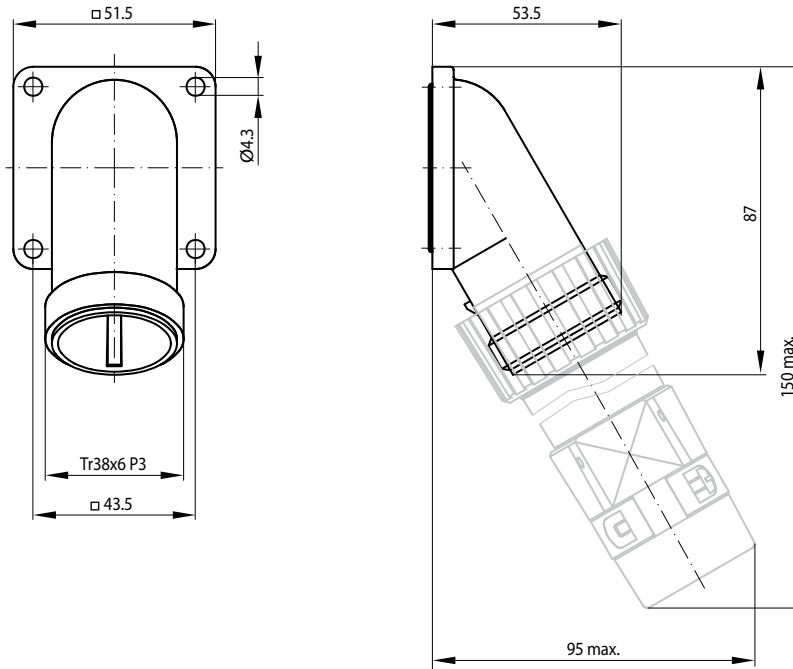

Ordering code	Description
M38	Flange mount angled receptacle

Note:

- All M3 inserts can be used with this receptacle

M3 Pg16, M3 Pg21, M3 M25, M3 M25D Backshells, Part 2

M3 VPg21 14-18 Cable glands

M3 series

• **M3 Pg16, M3 Pg21** Pg16 or Pg21 threaded backshells

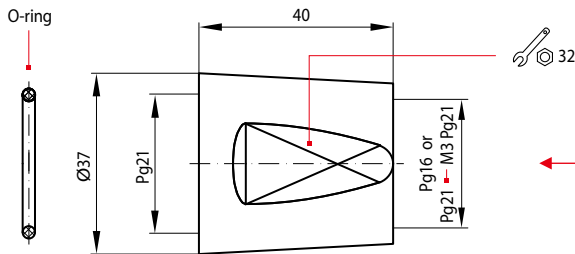

Ordering code	Description
M3 Pg16	Backshell with Pg21 threaded front and Pg16 threaded rear skirt for use with plug M36 W and receptacle M34 Pg21
M3 Pg21	Backshell with Pg21 threaded front and rear skirt for use with plug M36 W and receptacle M34 Pg21

• **M3 VPg21 14-18** Pg21 threaded cable glands

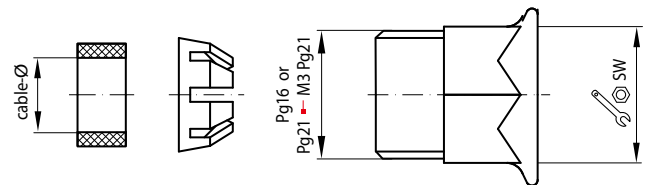

Ordering code	Description
—	Pg16 threaded cable gland (OEM part)
M3 VPg21 14-18	Pg21 threaded cable gland for use with backshell M3 Pg21

• **M3 M25, M3 M25D** M25x1.5 threaded backshells

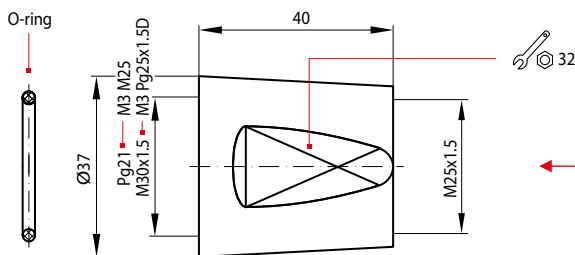

Ordering code	Description
M3 M25	Backshell with Pg21 threaded front and M25x1.5 threaded rear skirt for use with plug M36 W
M3 M25D	Backshell with Pg21 threaded front and M25x1.5 threaded rear skirt for use with receptacle M34 Pg21

• **M3 VM25 11-17** M25x1.5 threaded cable gland

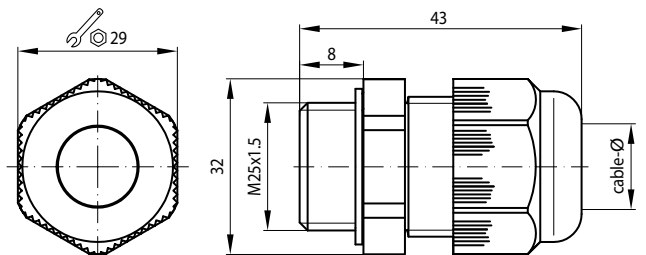

Ordering code	Description
M3 VM25 11-17	M25x1.5 threaded cable gland for use with backshells M3 M25 and M3 M25D

T28-xx/xx Cable sleeves, Shells Part 2

M3 series

• T28-xx/xx Cable sleeves

T28-10/13
T28-13/16
T28-16/18.5
T28-18.5/20.5
T28-20.5/22

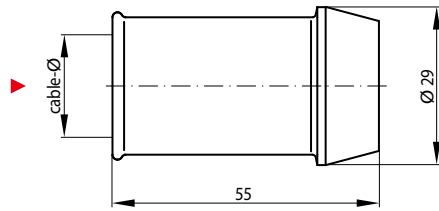

Ordering code	Description
T28-10/13	cabl-Ø 10 ... 13 mm
T28-13/16	cabl-Ø 13 ... 16 mm
T28-16/18.5	cabl-Ø 16 ... 18.5 mm
T28-18.5/20.5	cabl-Ø 18.5 ... 20.5 mm
T28-20.5/22	cabl-Ø 20.5 ... 22 mm

Note:

- For use with M36, M36 Z, M36 ZB Series cable plugs
- For use with M31 Z, M31 ZB Series cable receptacles

222K163-15, 202K163-15 Shrink boots, Shells Part 2

M3 series

• 222K163-15 Shrink boot, 90°

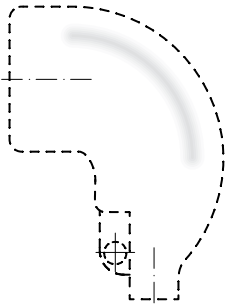

• 202K163-15 Shrink boot, straight

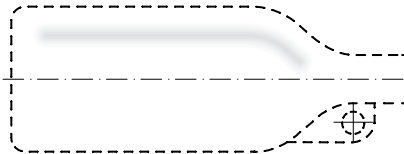

Ordering code	Description
222K163-15 *	Shrink boot, 90°
202K163-15 *	Shrink boot, straight

Note:

- For use with M36 W Series plug and M33 W Series receptacle
- Cable diameter Ø 9.9 mm min.
- * Order direct from Raychem

M3 KS, M3 K Protection caps for plugs

M3 DS, M3 D Protection caps for receptacles

M3 series

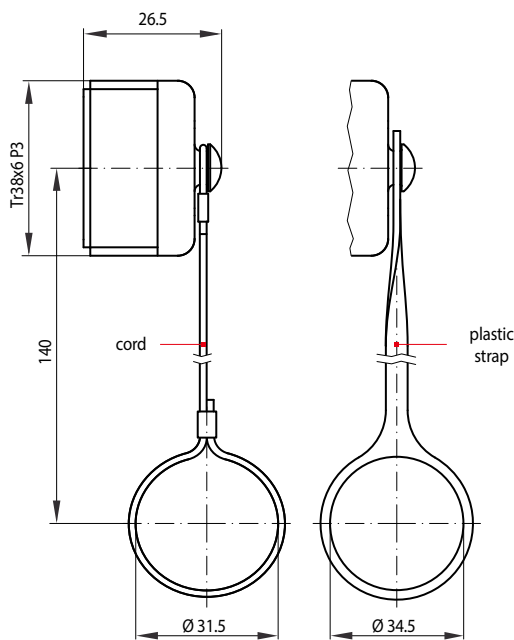

M3 KS

M3 K

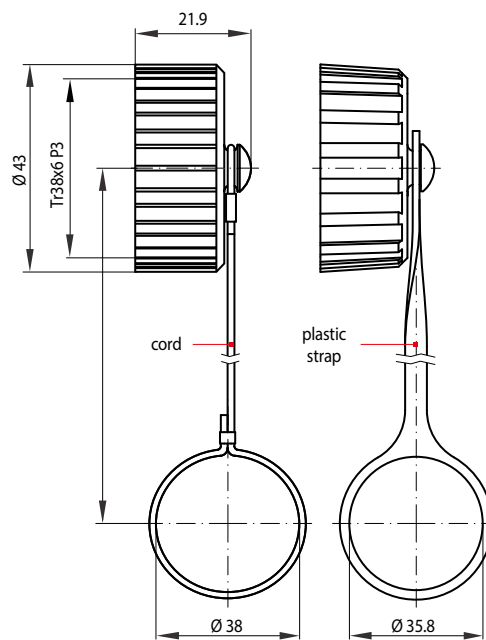

M3 DS

M3 D

Ordering code	Description
M3 KS	Protection cap with cord for plugs
M3 K	Protection cap with plastic strap for plugs

Ordering code	Description
M3 DS	Protection cap with cord for receptacles
M3 D	Protection cap with plastic strap for receptacles

M3 E-6P+PE / E-5P+3P+PE / E-12P+PE / E-7P+7P+PE Pin inserts 6, 5+3, 12 and 7+7 pole + PE

M3 E-6S+PE / E-5S+3S+PE / E-12S+PE / E-7S+7S+PE Socket inserts 6, 5+3, 12 and 7+7 pole + PE

M3 series

● Pin insert M3 E-6P+PE

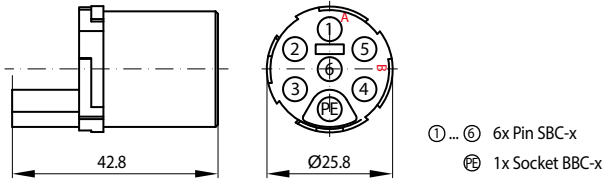

● Socket insert M3 E-6S+PE

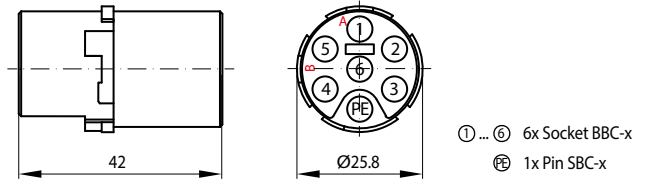

● Pin insert M3 E-5P+3P+PE

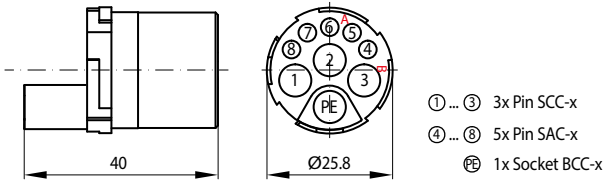

● Socket insert M3 E-5S+3S+PE

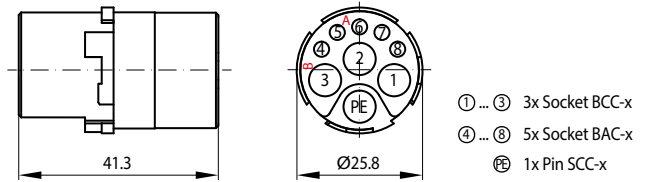

● Pin insert M3 E-12P+PE

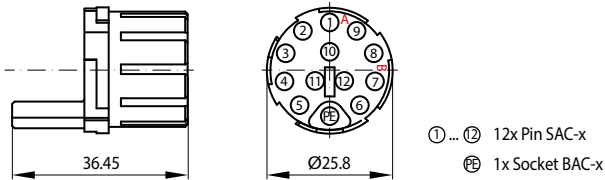

● Socket insert M3 E-12S+PE

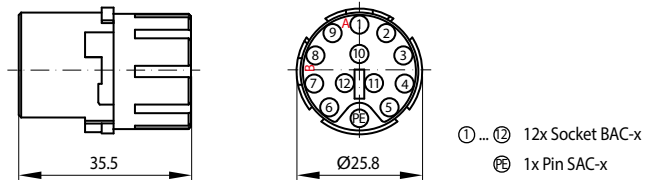

● Pin insert M3 E-7P+7P+PE

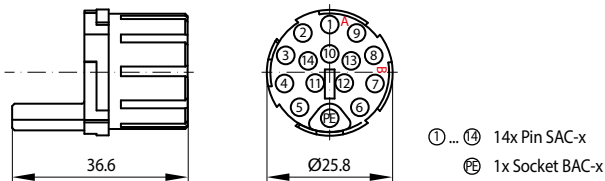

● Socket insert M3 E-7S+7S+PE

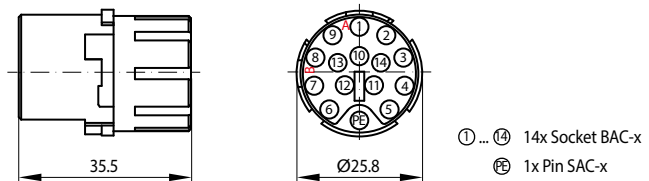

M3 Series: Number of contacts, max.		6 + PE	5+3 + PE	12 + PE	7+7+ PE
Ordering code	Pin insert	M3 E-6P+PE	M3 E-5P+3P+PE	M3 E-12P+PE	M3 E-7P+7P+PE
	Socket insert	M3 E-6S+PE	M3 E-5S+3S+PE	M3 E-12S+PE	M3 E-7S+7S+PE
Contact arrangement					
Contact identification as marked on insert:					
Pin insert: Rear view					
Socket insert: Front view					
Rated voltage (IEC 60038) At pollution degree PD3 (IEC 60512)		230 V / 400 V 1 ... 6	230 V / 400 V 25 V 1 ... 3 4 ... 8	250 V 1 ... 12	250 V 200 V 1, 2, 4, 5, 6, 7, 9 3, 8, 10 ... 14
Orientations		2	1	2	2
Contacts					
Current rating of individual contacts, max. *1		6x 32 A	3x 50 A 5x 16 A	12x 16 A	14x 16 A
Contact diameter		Ø 2.30 mm	Ø 4.0 mm Ø 1.58 mm	Ø 1.58 mm	Ø 1.58 mm
Contact Type *2					
Pin insert		SBC-x / PE: BBC-x	SCC-x / dto. PE*3 SAC-x	SAC-x / PE: BAC-x	SAC-x / PE: BAC-x
Socket insert		BBC-x / PE: SBC-x	BCC-x / dto. PE*3 BAC-x	BAC-x / PE: SAC-x	BAC-x / PE: SAC-x

*1 Depending on wire gauge (see »Specifications«, page 3) as well as operating temperature (see »Derating diagrams«, page 19)

*2 For a detailed description see »Contacts«, page 18

*3 Mind that only with the 8 pole inserts the PE contact is of the same contact gender. With the other inserts it is of the opposite gender.

Note:
Empty cavities should be fitted with filler plugs. See also page 18.

Contacts Crimp contacts (pin/socket) and filler plugs

M1, M3 series

Contacts

● SAC-x, BAC-x, BS-A-V10 Crimp contacts (pin/socket) and filler plug, type **A**

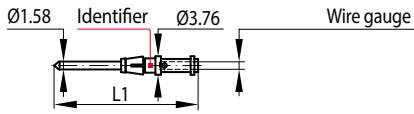

Pin contacts, silver plated

Ordering code	L1	Identification
SAC-0.50-Ag	28.6	No groove
SAC-1.00-Ag	28.6	1 groove
SAC-1.50-Ag	28.6	2 grooves
SAC-2.50-Ag	28.6	3 grooves

Pin contacts, gold plated

Ordering code	L1	Identification
SAC-0.50-Au	28.6	No groove
SAC-1.00-Au	28.6	1 groove
SAC-1.50-Au	28.6	2 grooves
SAC-2.50-Au	28.6	3 grooves

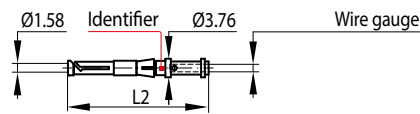

Socket contacts, silver plated

Ordering code	L2	Identification
BAC-0.50-Ag	28.6	No groove
BAC-1.00-Ag	28.6	1 groove
BAC-1.50-Ag	28.6	2 grooves
BAC-2.50-Ag	28.6	3 grooves

Socket contacts, gold plated

Ordering code	L2	Identification
BAC-0.50-Au	28.6	No groove
BAC-1.00-Au	28.6	1 groove
BAC-1.50-Au	28.6	2 grooves
BAC-2.50-Au	28.6	3 grooves

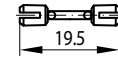

Filler plug:

BS-A-V10: Empty cavities can be fitted with filler plugs

Specifications

Wire gauge	Current rating
AWG 20 (0.5 mm ²)	7.5 A
AWG18...17 (0.75 ... 1 mm ²)	10 A
AWG15 (1.5 mm ²)	16 A
AWG13 (2.5 mm ²)	16 A

Specifications

Wire gauge	Current rating
AWG 20 (0.5 mm ²)	7.5 A
AWG18...17 (0.75 ... 1 mm ²)	10 A
AWG15 (1.5 mm ²)	16 A
AWG13 (2.5 mm ²)	16 A

● SBC-x, BBC-x, BS-B-V10 Crimp contacts (pin/socket) and filler plug, type **B**

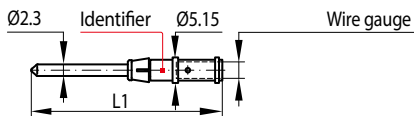

Pin contacts, silver plated

Ordering code	L1	Identification
SBC-0.50-Ag	40.4	No groove
SBC-1.00-Ag	40.4	1 groove
SBC-1.50-Ag	40.4	2 grooves
SBC-2.50-Ag	39.0	3 grooves
SBC-4.00-Ag	39.0	1 wide groove
SBC-6.00-Ag	39.0	2 wide grooves

Pin contacts, gold plated

Ordering code	L1	Identification
SBC-0.50-Au	40.4	No groove
SBC-1.00-Au	40.4	1 groove
SBC-1.50-Au	40.4	2 grooves
SBC-2.50-Au	39.0	3 grooves
SBC-4.00-Au	39.0	1 wide groove
SBC-6.00-Au	39.0	2 wide grooves

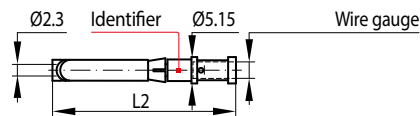

Socket contacts, silver plated

Ordering code	L2	Identification
BBC-0.50-Ag	37.0	---
BBC-1.00-Ag	37.0	1
BBC-1.50-Ag	37.0	2
BBC-2.50-Ag	35.6	3
BBC-4.00-Ag	35.6	4
BBC-6.00-Ag	35.6	5

Socket contacts, gold plated

Ordering code	L2	Identification
BBC-0.50-Au	37.0	---
BBC-1.00-Au	37.0	1
BBC-1.50-Au	37.0	2
BBC-2.50-Au	35.6	3
BBC-4.00-Au	35.6	4
BBC-6.00-Au	35.6	5

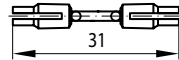

Filler plug:

BS-B-V10: Empty cavities can be fitted with filler plugs

Specifications

Wire gauge	Current rating
AWG 20 (0.5 mm ²)	7.5 A
AWG17 (1.0 mm ²)	10 A
AWG15 (1.5 mm ²)	16 A
AWG13 (2.5 mm ²)	27.5 A
AWG 11 (4.0 mm ²)	35 A
AWG9 (6.0 mm ²)	35 A

Specifications Daten

Wire gauge	Current rating
AWG 20 (0.5 mm ²)	7.5 A
AWG17 (1.0 mm ²)	10 A
AWG15 (1.5 mm ²)	16 A
AWG13 (2.5 mm ²)	27.5 A
AWG 11 (4.0 mm ²)	35 A
AWG9 (6.0 mm ²)	35 A

● SCC-x, BCC-x, BS-C-V10 Crimp contacts (pin/socket) and filler plug, type **C**

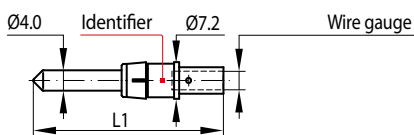

Pin contacts, silver plated

Ordering code	L1	Identification
SCC-2.50-Ag	37.5	3 grooves
SCC-4.00-Ag	37.5	1 wide groove
SCC-6.00-Ag	37.5	2 wide grooves

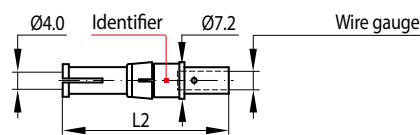

Socket contacts, silver plated

Ordering code	L2	Identification
BCC-2.50-Ag	32.6	3 grooves
BCC-4.00-Ag	32.6	1 wide groove
BCC-6.00-Ag	32.6	2 wide grooves

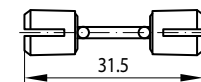

Filler plug:

BS-C-V10: Empty cavities can be fitted with filler plugs

Specifications

Wire gauge	Current rating
AWG13 (2.5 mm ²)	27.5 A
AWG 11 (4.0 mm ²)	35 A
AWG9 (6.0 mm ²)	50 A

Note:

- Schaltbau recommends the use of crimp tool CWZ-600-1 (see page 21) for all contacts except SAC-2.50-xx and BAC-2.50-xx. For SAC-2.50-xx and BAC-2.50-xx contacts we recommend the Buchanan M22520/1-01(-02) crimp tool.
- Schaltbau recommends CuSn conductors (tinned) when the connectors are used:
 - under extreme ambient air temperatures of +60°C... +100°C or -25°C... 0°C
 - under conditions of extreme fluctuation of temperature and humidity
- PE (protection earth) contacts must be of the same AWG size as the main contacts.

Filler plugs:

- Fill the empty cavities with filler plugs from the mating face
- Cavities of pin inserts can only be filled with half a filler plug
- Packaging unit: 10 pieces

Contacts Ordering code

M1, M3 series

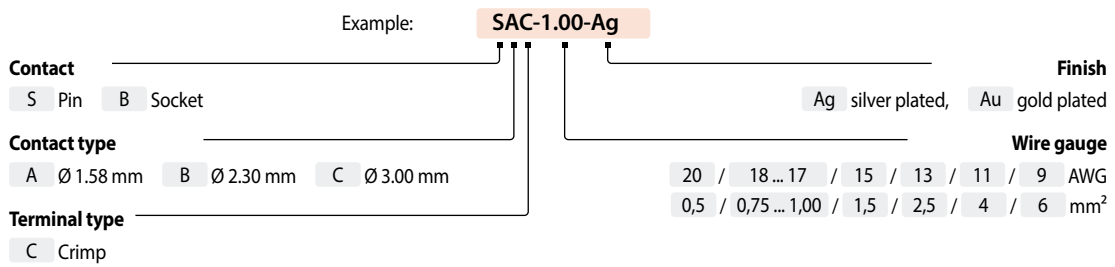

Contacts

Derating diagrams

M1, M3 series

• Derating curve M1 E4P+PE and M1 E4S+PE

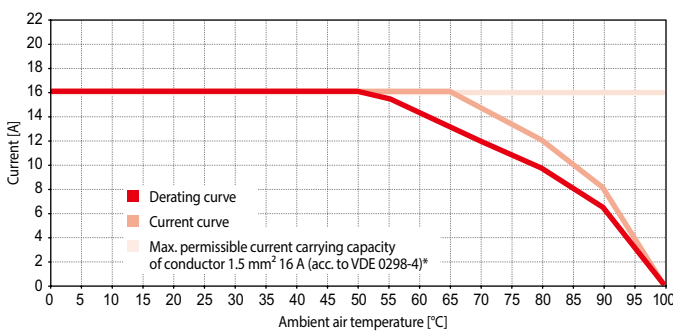

• Derating curve M1 E6P+PE and M1 E6S+PE

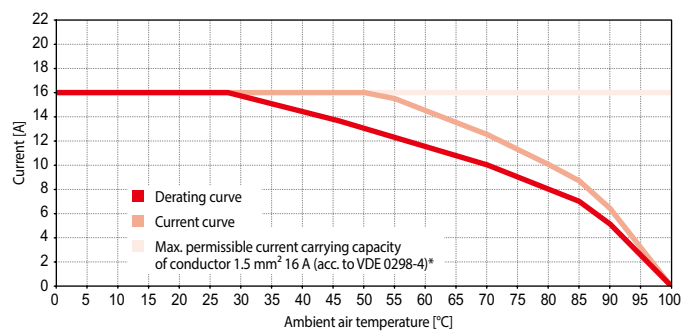

• Derating curve M3 E6P+PE and M3 E6S+PE

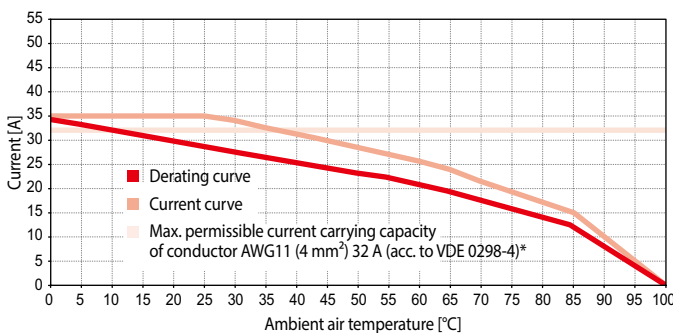

• Derating curve M3 E5P+3P+PE and M3 E5S+3S+PE

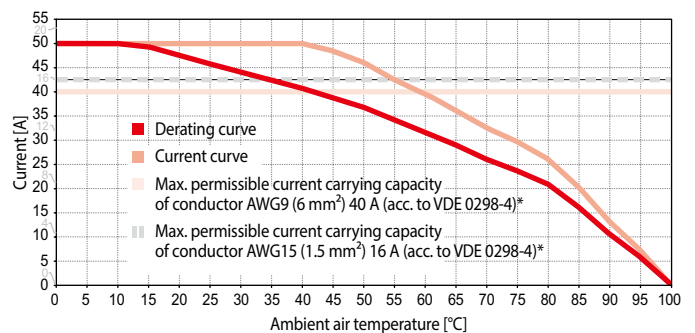

• Derating curve M3 E12P+PE and M3 E12S+PE

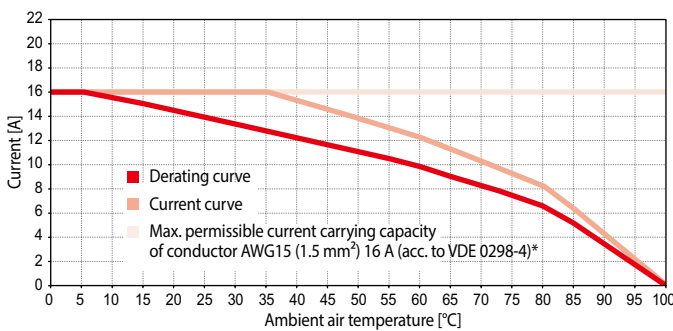

• Derating curve M3 E7P+7P+PE and M3 E7S+7S+PE

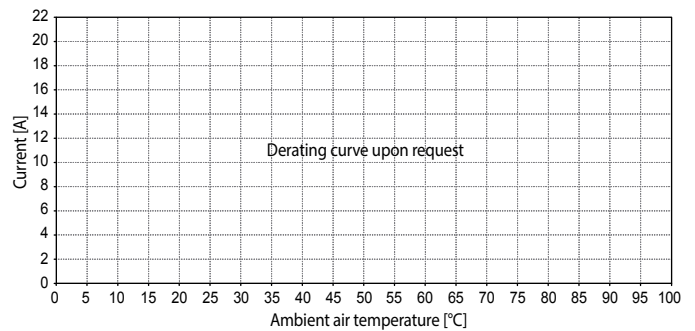

Notes:

- According to VDE 0298-4 the wire gauge of the conductor should be determined in this way that within the limits of its specified current carrying capacity there will be no heating of the conductor exceeding the permissible operating temperature at any place or at any time.
- The derating diagrams show the permissible operating range.
- Control and test procedures according to IEC 60512-3, test 5b.



Notes:

* For AWG sizes refer to our [AWG Electrical Wire Conversion Table](#)

Tools

M1, M3 series

● Insertion tools for socket inserts



Ordering code	Insertion tools for
VW-M1 E-4S	Contact insert M1 E-4S+PE
VW-M1 E-6S	Contact insert M1 E-6S+PE
VW-M3 E-6S	Contact insert M3 E-6S+PE
VW-M3 E-5S+3S	Contact insert M3 E-5S+3S+PE
VW-M3 E-12S	Contact insert M3 E-12S+PE, M3 14S+PE

● Insertion tools for pin inserts



Ordering code	Insertion tools for
VW-M1 E-4P	Contact insert M1 E-4P+PE
VW-M1 E-6P	Contact insert M1 E-6P+PE
VW-M3 E-6P	Contact insert M3 E-6P+PE
VW-M3 E-5P+3P	Contact insert M3 E-5P+3P+PE
VW-M3 E-12P	Contact insert M3 E-12P+PE, M3 14P+PE

● Extraction tool



Ordering code	Extraction tool for
AWZ-A	Contacts type A
AWZ-B	Contacts type B
AWZ-C/H	Contacts type C/H

● Crimp tool



Ordering code	Crimp tool for
CWZ-600-1	Contacts SAC-x*, BAC-x*, SBC-x, BBC-x, SCC-x, BCC-x * Do not use for contacts SAC-2.50-xx, BAC-2.50-xx
Tool frame M22520/1-01 & Turret M22520/1-02 (No fig.)	For contacts SAC-2.50-xx, BAC-2.50-xx only. Crimp tool and turret from DMC or Buchanan. Order direct from OEM.

Mounting holes

M1, M3 series

● Flange mount receptacles and plugs

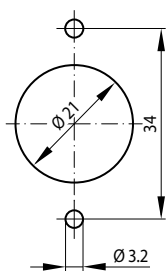

M13, M15

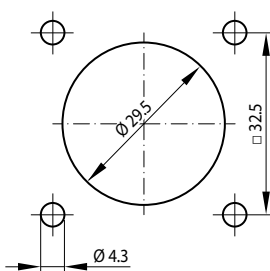

M33, M33 W, M35

● Flange mount angled receptacles

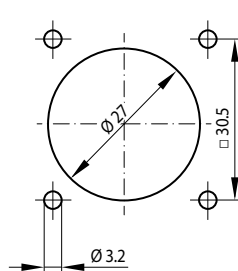

M18

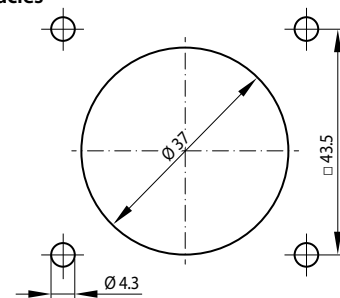

M38

● Receptacles with threaded rear skirts

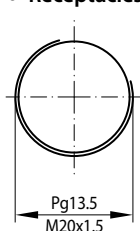

M14

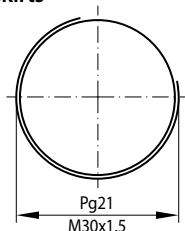

M34

Installation and safety instructions

M1, M3 series

The circular industrial connectors dealt with in this catalogue are intended for use with low-voltage systems and special installations. They are designed and tested in compliance with the generally recognised state of the art. However, the improper use, operation, handling, maintenance of or tampering with electric equipment can cause serious or fatal injury to the user or others, and the appliance or other property can be damaged.

Only authorized and trained personnel are allowed to plan and carry out all mechanical and electrical installations, transport, commissioning, as well as maintenance and repair work. This applies to the observation of the general installation and safety regulations for low-voltage systems as well as the proper use of tools approved for this purpose. Electric equipment requires protection from moisture and dust during installation, operation and storage.



Due to our continuous improvement programme, the design of our products can be modified at any time. So some features may differ from the descriptions, specifications and drawings in the catalogue. You can download the latest update of the catalogue at schaltbau.info/download1en. The updated catalogue renders the previous issue invalid.



Electrical hazards: Any exposure to the connector's live parts. Risk of electrical shock!
 Observe all applicable national provisions, all safety, accident prevention and environmental regulations as well as the recognized technical rules for safe and proper working.

Installation instructions

- Work on electric equipment may only be performed by a qualified electrician or trained personnel working under the direction and supervision of a qualified electrician according to the applicable rules of electrical engineering.
- The connectors supply power and signals. They are intended for plug-in and detachable connections of components, devices and systems only.
- In order to comply with IEC 61984 make sure that always the current-carrying part of the connector – no matter whether plug or receptacle – is fitted with socket contacts.
- For optimum protection of the cable connection make sure the connector is supplied with a strain relief.
- According to IEC 60352-2 – “Solderless connections” – crimp contacts are required.
- Make sure that there is no undue strain, pressure, flexing and torsion on the cable connection.

Safety instructions

- Carry out regular inspections of all protection and safety devices to see if they work properly.
- According to IEC 61984 connectors used as intended must not be engaged or disengaged when live or under load.
- A connector that does not engage easily requires special attention: Check for the correct orientation or if its contacts got bent or polluted. Never use force! The connector should always engage easily.
- To prevent dust and moisture from entering, make sure that the connector, when not mated, is covered by the protective cap.
- When disengaging a connector, pull the plug and never the cable.
- Use the connector only according to its intended use. Replace or repair damaged parts exclusively with original parts. Any other usage of or tampering with the connector is considered contrary to its intended use. No liability is assumed for damages and accidents caused due to non-compliance with the instructions or improper use of the connector.
- The connectors are designed for special environmental conditions as defined by “Specifications” on page 3 of this catalogue. Any use which goes beyond the limits of these specifications is not regarded as the intended use of the connector.

Installation and maintenance instructions M Series



For a detailed list of all safety, installation and maintenance instructions, download our manual [A10-M.en!](#)

Visual inspections

Be sure to make visual inspections regularly. Improper handling of the connector, e.g. when hitting the floor with some impact, can result in breakage, visible cracks and deformation..



Defective and/or leaky parts must be replaced instantaneously!

Schaltbau GmbH

For detailed information on our products and services visit our website – or give us a call!

Schaltbau GmbH
Hollerithstrasse 5
81829 Munich
Germany



Phone +49 89 9 30 05-0
Fax +49 89 9 30 05-350
Internet www.schaltbau.com
e-Mail contact@schaltbau.de

with compliments:



The production facilities of Schaltbau GmbH have been IRIS certified since 2008.



Certified to DIN EN ISO 14001 since 2002. For the most recent certificate visit our website.



Certified to DIN EN ISO 9001 since 1994. For the most recent certificate visit our website.

Electrical Components and Systems for Railway Engineering and Industrial Applications

Connectors

- Connectors manufactured to industry standards
- Connectors to suit the special requirements of communications engineering (MIL connectors)
- Charging connectors for battery-powered machines and systems
- Connectors for railway engineering, including UIC connectors
- Special connectors to suit customer requirements

Snap-action switches

- Snap-action switches with positive opening operation
- Snap-action switches with self-cleaning contacts
- Snap-action switch made of robust polyetherimide (PEI)
- Snap-action switch with two galvanically isolated contact bridges
- Special switches to suit customer requirements

Contactors Emergency disconnect switches

- Single and multi-pole DC contactors
- High-voltage AC/DC contactors
- Contactors for battery powered vehicles and power supplies
- Contactors for railway applications
- Terminal bolts and fuse holders
- DC emergency disconnect switches
- Special contactors to suit customer requirements

Electrics for rolling stock

- Equipment for driver's cab
- Equipment for passenger use
- High-voltage switchgear
- High-voltage heaters
- High-voltage roof equipment
- Equipment for electric brakes
- Design and engineering of train electrics to customer requirements